





## 4.1 Summary

---

Section 4 is the culmination of the Central Sydney Planning Strategy and the research, analysis and context which precedes it. This section details the objectives and actions provisions of how the Strategy will be achieved and provides a timeline for implementation. It reiterates the Strategy's key moves and then the more specific and technical descriptions of the planning controls that will deliver them.

The controls and actions of the Strategy facilitate the growth of Central Sydney. They ensure that economic and employment growth is balanced with the need to develop a liveable, diverse and welcoming city supported by great quality-of-life factors and infrastructure. A sound balance between sustainable growth, a healthy environment and strong infrastructure will ensure a resilient Central Sydney with a high standard of living.

## 10 key moves

The Strategy's key moves are the main components of the Central Sydney Planning Strategy that address the most important issues for planning for growth.

### key moves

|    |   |
|----|---|
| 1  | Prioritise employment growth and increase capacity                              |
| 2  | Ensure development responds to context  |
| 3  | Consolidate and simplify planning controls                                      |
| 4  | Protect, enhance and expand Central Sydney's heritage, public places and spaces |
| 5  | Ensure infrastructure keeps pace with growth                                    |
| 6  | Move towards a more sustainable city  |
| 7  | Protect, enhance and expand heritage and public places                          |
| 8  | Move people more easily   |
| 9  | Reaffirm commitment to design excellence  |
| 10 | Monitor outcomes and respond  |

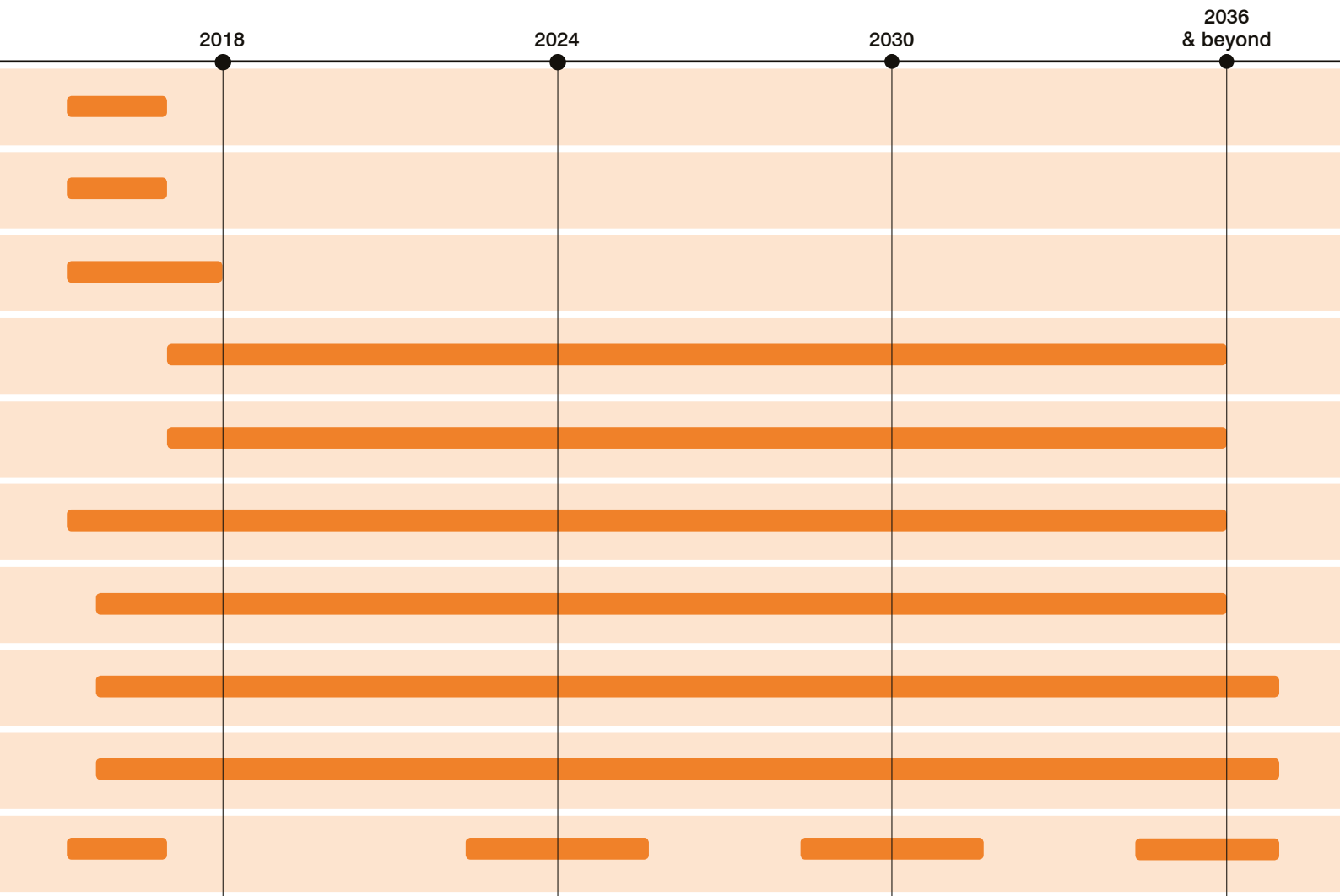

timeline for delivery

## Structure Plan

The Structure Plan at 4\_1 shows the key structural elements that the Implementation Strategy for Central Sydney has to work with, such as transport nodes, pedestrian walkways, public parks and zones for shopping and events.

The underpinning philosophy of the implementation strategy is based on three considerations: ensuring excellent open spaces for the enjoyment of all, connecting parts of Central Sydney to each other and beyond; and planning for the future density of the city, particularly from increased commercial activity.

### Open space

Central Sydney is supported by a system of high-quality green open spaces and the Sydney Harbour Foreshore. Three significant new public squares are proposed to support the existing open space network and to provide a variety of open space experiences. These will be located at Circular Quay, Town Hall and Central Railway Station connected by a new George Street pedestrian spine.

### Connectivity

Central Sydney is currently undergoing significant improvements in its public transport system and this will be enhanced by an improved pedestrian and cycle network.

The future Light Rail and Metro networks will supplement the existing heavy rail network enabling a 50 per cent increase in capacity during critical peak times.

Existing and proposed open space as well as the proposed new density zones will be connected by a series of prioritised pedestrian links. Major prioritised links will connect north–south and a fine grain system of links will connect east–west. These east–west links will particularly serve to break down the barriers of roads and long blocks restricting connectivity to the western foreshore and Barangaroo.

### Future density

Three new zones for potential major tower clusters are identified in locations deemed to be least constrained by sun access planes. In these areas, increased heights and floor space will capitalise on the increased capacity within Central Sydney as a result of improved public transport connectivity.

4\_1  
Structure plan

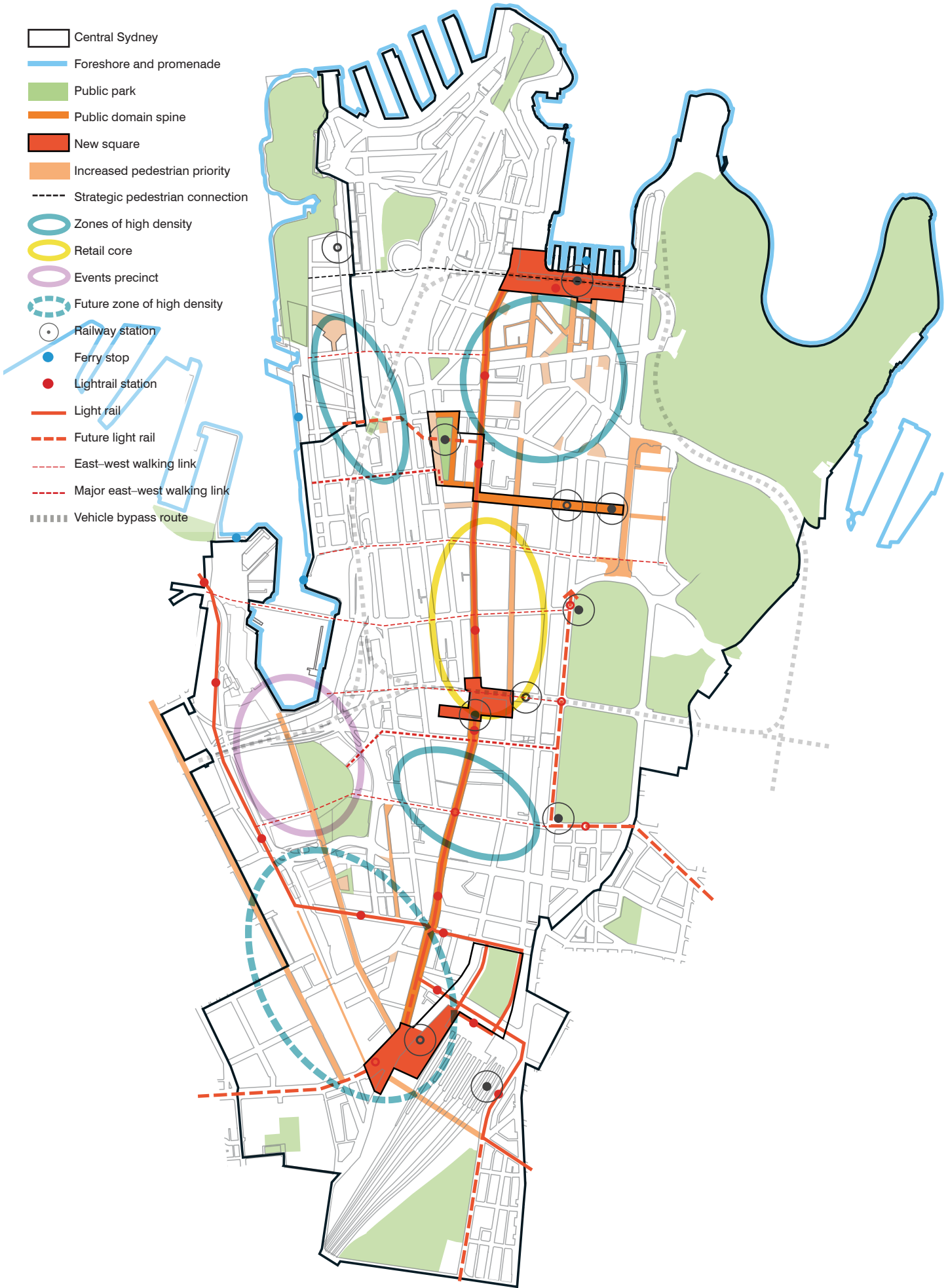

## Supporting project ideas

Most of the Strategy's actions will be delivered through the planning system and private development; however, the City has a role in delivering and facilitating government projects. Some projects will support growth, others will increase transport efficiency and others improve urban amenity.

### Catalytic project ideas to facilitate growth

1. Build Town Hall Square and hold open international design competitions for:
  - a. Circular Quay Station, Cahill Expressway bus interchange, ferry wharves and square
  - b. Wynyard Park
  - c. Railway Square and Belmore Park
2. Extend George Street pedestrianisation to Circular Quay and Railway Square
3. Continue to upgrade all streets in Central Sydney for pedestrian comfort starting at the south end of Central Sydney including Quay Street and a link from the Goods Line to Railway Square
4. Link Hyde Park north and south with a pedestrian bridge
5. Upgrade pedestrian crossings at busy intersections providing more waiting space and shorter wait times and work with Transport for NSW to develop a Pedestrian Level of Service & Comfort Standard
6. Introduce car-free days in the retail core during peak weekends of Christmas Shopping
7. Complete the regional separated cycle network connections to Central Sydney
8. Work with Transport for NSW to reduce the number of buses and complexity of bus routes in Central Sydney
9. Begin planning for light rail on Oxford, Liverpool and Elizabeth Streets
10. Develop "Smarter Poles and Awnings" to collect city data including temperature, wind speeds and direction, pollution, pollen, noise, pedestrian and vehicle numbers, and make the data publicly available in real time

#### 4\_2

Wynyard Park



#### 4\_3

Future Town Hall Square



#### 4\_4

Hyde Park

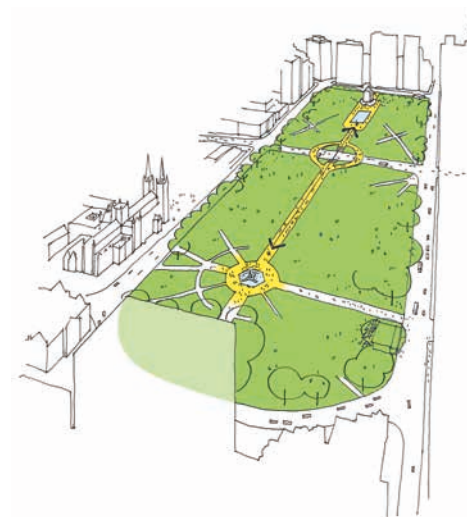



4\_5  
Circular Quay Square

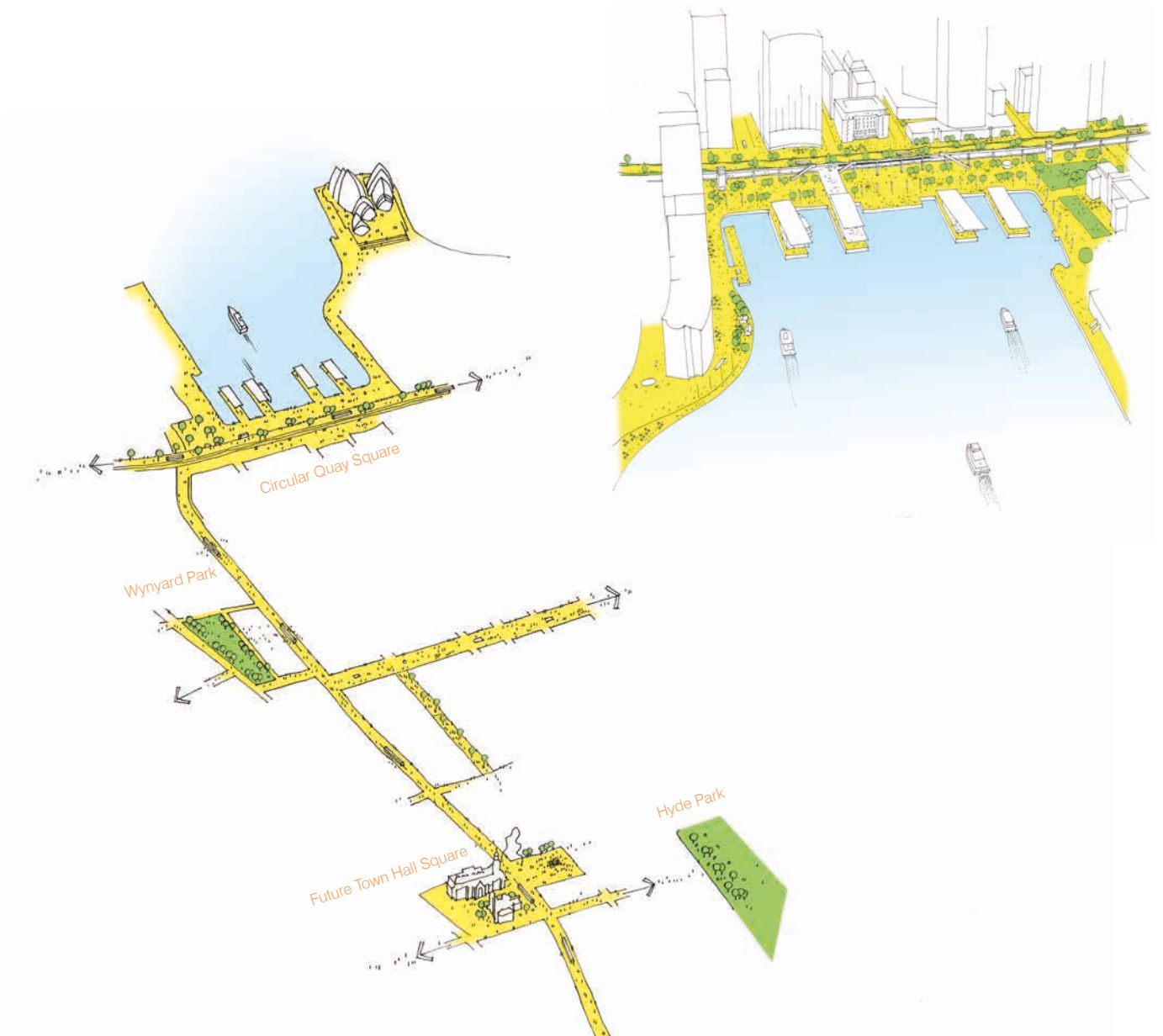

4\_6  
Railway Square and Belmore Park

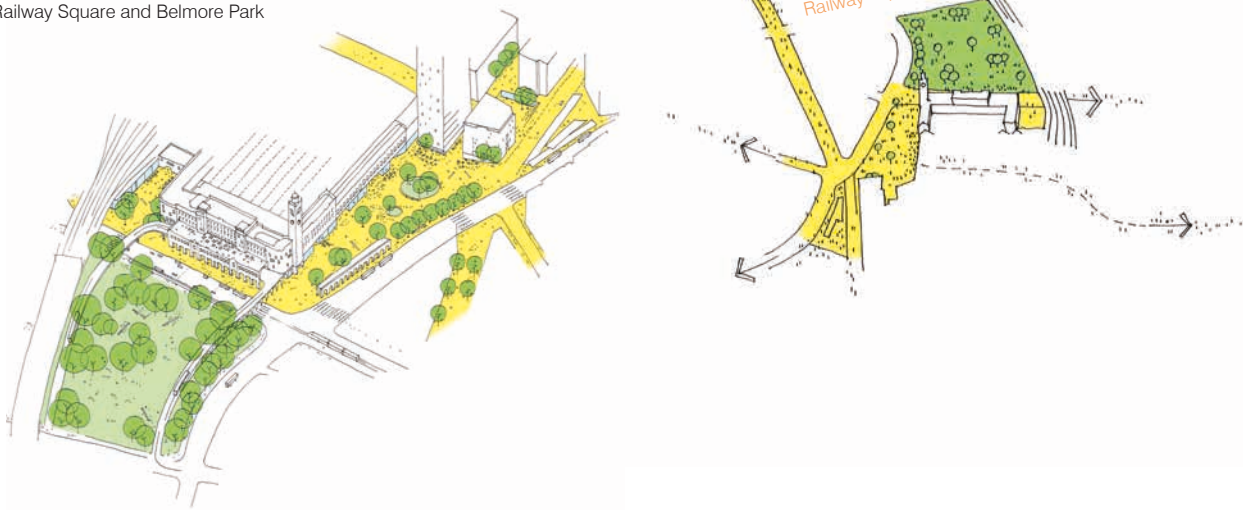



## 4.2

### Objectives and actions

---

## 01 | Land use

Central Sydney is predominantly governed by two land use zones: the B8 Metropolitan Centre Zone and the RE1 Public Recreation Zone. The objectives of the zones provide certainty to the community about the intent of the zone and the desired future role and form of the area.

### Metropolitan centre zone

#### Objectives

- To recognise and provide for the pre-eminent role of business, office, retail, entertainment and tourist premises in Australia's participation in the global economy
- To provide opportunities for an intensity of land uses commensurate with Sydney's global status
- To permit a diversity of compatible land uses characteristic of Sydney's global status and that serve the workforce, visitors and wider community
- To encourage the use of alternatives to private motor vehicles, such as public transport, walking or cycling
- To promote uses with active street frontages within podiums that contribute to the vitality, life and existing character of the street
- To promote the efficient and orderly development of land in a compact urban centre
- To promote a diversity of commercial opportunities varying in size, type and function, including new cultural, social and community facilities
- To recognise and reinforce the important role that Central Sydney's public spaces, streets and their amenity play in a global city
- To only permit residential and serviced apartment accommodation as part of mixed-use developments that complement the primary role of the zone as a centre for employment

### Public recreation zone

#### Objectives

- To enable land to be used for public open space or recreational purposes
- To provide a range of recreational settings and activities and compatible land uses
- To protect and enhance the natural environment for recreational purposes
- To provide links between open space areas
- To retain and promote access by members of the public to areas in the public domain including recreation facilities and waterways and other natural features
- To protect sun access to publicly accessible land

#### Priority actions

- 1.1 Strengthen and update zone objectives in Sydney LEP 2012 to reinforce the important role that employment floor space plays in a global city
- 1.2 Strengthen and update public recreation zone objectives in Sydney LEP 2012 to highlight the importance of sun access to amenity and usability, and the contribution sun lit public space plays in maintaining Sydney's status as a global city
- 1.3 Increase public confidence in local planning decisions by working with the NSW Government to revise state significant cost thresholds for:
  - Alterations and additions over \$10 million for state-listed heritage items
  - Hotels (new and refurbishments) over \$100 million
  - All development over \$10 million in the Rocks, Darling Harbour and Central Park
  - Education establishments (new and refurbishments) over \$30 million, and
  - Cultural, recreation and tourist facilities (new and refurbishments) over \$30 million, where the NSW Government is currently the planning authority.
- 1.4 Increase public confidence in local planning decisions by working with the NSW Government to transfer land state-significant land back to the City of Sydney, including:
  - The Rocks, and
  - Darling Harbour.
- 1.5 Transfer land to Sydney LEP 2012 and the B8 Metropolitan Centre zone including:
  - Ultimo south
  - Central Park
  - University of Technology Sydney
  - Chippendale north-west
  - Surry Hills west
  - Centennial Plaza, and
  - The Central Railway Station Group (inclusive of blocks bound by Eddy Avenue, Chalmers Street, Cleveland Street, Regent Street, Lee Street and Pitt Street).

#### Other actions

- 1.6 Develop a monitoring program with the NSW Government to track the net growth of employment floor space, overseen by the Central Sydney Planning Committee
- 1.7 Regularly review and adjust planning controls as required to deliver the planning and land use directions of the City's Sustainable Sydney 2030, the NSW Government's A Plan for Growing Sydney and the Central Sydney Planning Strategy, including where required:
  - Lowering the maximum percentage of non-employment uses
  - Potentially requiring a percentage net increase in employment floor space on any redeveloping site
  - Precinct specific or Central Sydney wide use prohibition

4.7

Amended zoning map

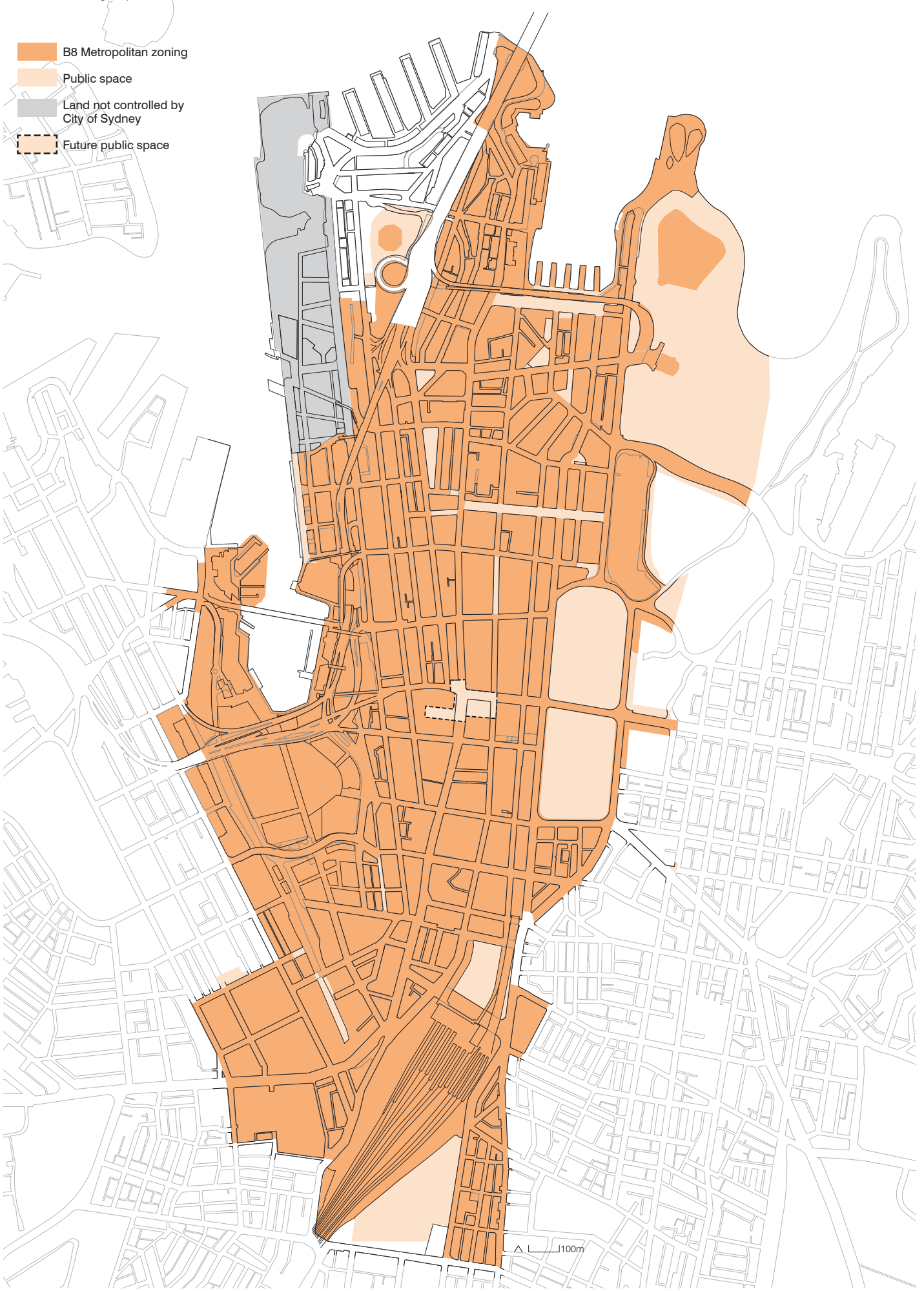

## 02 | Density

The Strategy differentiates density controls from the City of Sydney’s more generic density controls by prioritising employment floor space in Central Sydney.

Existing density controls will be revised and additional density will be permitted on a site-by-site basis through negotiated outcomes. Floor space ratio controls will continue to be a key tool used by the City of Sydney to achieve the following positive outcomes:

- **Order:** If several sites work together to pool their density across boundaries, each site can realise its maximum development potential.
- **Form:** Podium and tower forms maximise the amount of floor space and provide the best environmental outcomes. Podiums frame public space and ameliorate wind impacts; towers have self-sufficient amenity and maximise daylight to public places and streets.
- **Function:** Floor space for employment uses is a priority, and small sites that are inappropriate for employment uses provide opportunities for residential uses in areas where a residential character has been established.
- **Heritage:** Unrealised development potential can be transferred from a heritage-listed site to another site if heritage conservation works are completed.
- **Balance:** Dense cities can be the healthiest, greenest, most stimulating place for people with the least environmental footprint, but we have a shared responsibility to deliver physical, community and social infrastructure that will support increased density.

### Floor Space Control

The Floor Space Ratio (FSR) control is the “base” floor space that may be achieved on all sites in Central Sydney. Expressed as a floor space permitted to site area ratio (floor space permitted:site area), the FSR across Central Sydney is predominantly 8:1, with a slightly lower base of 7.5:1 for the southern precinct. Floor space permitted above the FSR control has historically been successfully used in Central Sydney to incentivise strategic planning outcomes.

#### Objectives

- To provide sufficient floor space to meet anticipated development needs for the foreseeable future
- To regulate the density of development, built form and land use intensity and to control the generation of vehicle and pedestrian traffic
- To provide for an intensity of development that is commensurate with the capacity of existing and planned infrastructure
- To ensure that new development reflects the desired character of the locality in which it is located and minimises adverse impacts on the amenity of that locality
- To provide an equitable amount of floor space to sites in Central Sydney which will accommodate a diversity of compatible land uses
- To increase the amount of employment floor space in Central Sydney to meet expected demand
- To ensure that in Central Sydney new development complements the mixed use, predominantly commercial character of streets and surrounding public spaces

| Area<br>(refer to 4_8)            | General location        | FSR permitted by Floor Space Ratio Map | Accommodation Floor Space | Key Use Floor Space  |
|-----------------------------------|-------------------------|--|---------------------------|--|
| City Core and Midtown<br>'Area 1' | Expanded City Core      | 8:1                                    | 4.5:1                     | 1.5:1<br>hotel, motel, community uses, child care                                |
| Western Edge<br>'Area 2'          | Existing Western Edge   | 8:1                                    | 2:1                       | 1.5:1<br>hotel, motel, community uses, child care                                |
| Southern<br>'Area 3'              | Chinatown and Haymarket | 7.5:1                                  | Not applicable            | 1.5:1<br>Office, business and retail premises, hotel, community uses, child care |

## Additional Floor Space

The Accommodation Floor Space density control represents floor space that is in addition to the Floor Space Ratio control and may only be achieved on sites if heritage floor space is allocated (purchased) from a heritage listed site that has been awarded heritage floor space for heritage conservation works completed. Further additional floor space may be considered as an incentive if key employment-related uses are provided in developments and the form of that floor space does not negatively impact on the amenity of surrounding public places in terms of daylight access and wind impacts.

### Objectives

- To provide for additional floor space to be granted as an incentive for development in Central Sydney where development promotes heritage conservation and ecologically sustainable development
- To maintain the framework for the transfer of development potential from the site of a heritage building to another site in Central Sydney
- To provide an incentive for a broad mix of uses within a single development
- To increase the amount of employment floor space in Central Sydney to meet expected demand
- To provide opportunities for additional floor space to be granted as an incentive for employment-related development, including office, business and retail premises; hotel accommodation and serviced apartments
- To provide for an intensity of development that is commensurate with the capacity of existing infrastructure
- To promote employment uses within building podiums, including cultural, social and community facilities
- To grant additional floor space where taller buildings give appropriate consideration to, and minimise their impact on, the amenity of surrounding public places in terms of daylight access and wind impacts

### Priority actions for floor space

- 2.1 Amend density objectives and controls in Sydney LEP 2012 to prioritise opportunities for employment floor space
- 2.2 Include new provisions establishing ecological sustainable development minimums
- 2.3 Revise the definition of “accommodation floor space” in Sydney LEP 2012 so that it is better aligned with its role in the allocation of heritage floor space (HFS)
- 2.4 Broaden the definition of “accommodation floor space” in Sydney LEP 2012 to promote mixed use development by allowing eligibility to additional “accommodation floor space” to all land use types
- 2.5 Rationalise Floor Space Ratio Map Areas in Central Sydney so that access to additional “accommodation floor space” is equalised in north and midtown precincts

- 2.6 Remove the complexity of calculating the eligible amount of accommodation floor space in Sydney LEP 2012
- 2.7 Provide an additional incentive for key land uses that support Central Sydney’s global city functions, such as hotel or motel accommodation, community facilities, childcare centres
- 2.8 Introduce new land use mix controls in Sydney LEP 2012 that will promote the growth of employment floor space
- 2.9 Introduce new land use mix controls in Sydney LEP 2012 that manage the growth of residential and serviced apartment floor space
- 2.10 Provide an additional incentive to development within the Western Edge of Central Sydney where there are opportunities for additional capacity, by increasing eligibility for additional floor space by an amount equivalent to FSR 0.5:1
- 2.11 Ensure when determining the ability for a taller development to go beyond 55 metres in height, that those developments give appropriate consideration to, and minimise their impact on, the amenity of surrounding public places in terms of daylight access and wind impacts

## Strategic Floor Space

Strategic Floor Space in the short to medium term represents floor space that exceeds the Floor Space Ratio and Additional Floor Space and may be achieved on sites by way of a site-specific planning proposal that complies with a planned guideline to preparing site-specific planning proposal requests in Central Sydney. Strategic Floor Space is limited to developments for employment uses. In the long term the City will seek to implement this process in Sydney LEP 2012.

Introducing a defined planning pathway for additional density (and height) will increase growth opportunities for employment floor space, promote the efficient use of land, and encourage innovative design. It will unlock opportunities for the delivery of cultural, social and essential infrastructure and improved public spaces commensurate with growth. By permitting additional density, but only through a managed process, the City can ensure the sustainable supply and growth of floor space while tempering speculation and moderating land prices.

### Objectives

- To provide opportunities for strategic floor space on appropriate sites that serve the workforce, visitors and wider community
- To provide opportunities on Strategic Opportunity Sites for additional height where significant public benefit can be demonstrated
- To ensure planning proposals align with the aims, objectives and actions of the Central Sydney Planning Strategy
- To ensure that planning proposals have planning and architectural merit
- To ensure that planning proposals commit to achieving sustainable development above minimum requirements
- To limit Strategic Floor Space to identified strategic uses
- To provide for an intensity of development that is commensurate with the capacity of existing and planned infrastructure, particularly public transport, open space and pedestrian infrastructure
- To require sharing of planning gain resulting from changes to planning controls to fund public infrastructure delivery with consideration given to development feasibility
- To describe the City's priorities for public infrastructure needed to support growth
- To provide a transparent and consistent approach to the evaluation of planning proposals in Central Sydney
- To describe the process for preparing a planning proposal, including required supporting documentation, and the decision-making process
- To ensure no overshadowing of protected places at key times

### Priority actions for strategic floor space

- 2.12 Prepare a guideline for site-specific planning proposal requests in Central Sydney to set a clear framework for how Strategic Floor Space can be accessed, which include compliance with solar access protection controls, setbacks and massing provisions
- 2.13 Limit access to Strategic Floor Space to strategic sites, to office premises, business premises, retail premises, hotel accommodation and community and cultural facilities
- 2.14 Ensure planning proposals that seek amendments to height and/or floor space ratio controls are for the purpose of employment development
- 2.15 Provide clear guidance and requirements for when exceptions to Sun Access Planes may be permitted that ensure no additional overshadowing of protected spaces at protected times
- 2.16 Describe a process for determining higher potential floor space ratios generally in accordance with the envelope to floor space efficiency considerations outlined in Appendix B. Allow an alternative method where higher floor space is determined through design testing that yields equal or better environmental performance than a complying envelope

### Other actions

- 2.17 Explore opportunities for innovative floor space transfer mechanisms in Central Sydney for developments that will increase employment floor space of Central Sydney
- 2.18 Prepare a framework for the transfer of unrealised commercial floor space potential from sites constrained by sun access planes from sites providing significant open space to unconstrained sites
- 2.19 Consider a streamlined pathway for planning proposals that transfer floor space between sites for employment-related development
- 2.20 Prepare a heritage floor space strategy for The Rocks and Darling Harbour
- 2.21 Work with the NSW Government to fully implement access to Strategic Floor Space in Sydney LEP 2012



4.8

Amended FSR map

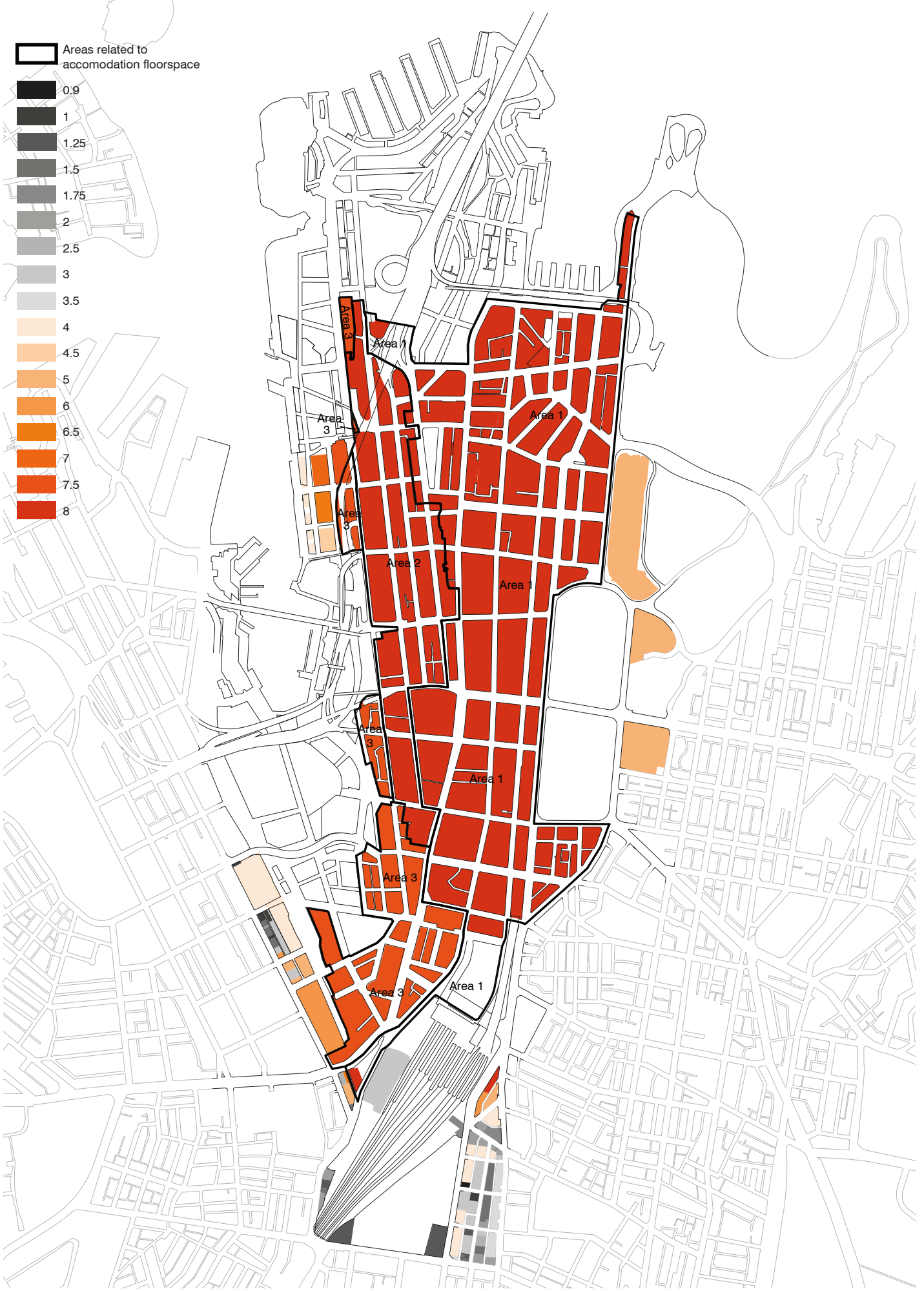

## 03 | Height

The Strategy's approach to height controls is based on the key principle of creating a liveable city. Central Sydney's parks, streets and precincts together play a key role in making Sydney a highly liveable city, so protecting their sunlight access is of key importance.

In Central Sydney, tall buildings are defined as those higher than 55 metres above ground. They perform a different role to street wall buildings and can have a significant impact on environmental conditions.

The Strategy provides opportunities for tall buildings to be built to greater height on appropriate sites where they will not overshadow protected spaces. They will include specific controls to manage their impacts and ensure they are efficient, self-sufficient and align with the strategic objectives for land use and density in Central Sydney. Some areas within Central Sydney are unsuitable for tall buildings such as those with narrow street blocks, close to significant public places or with heritage considerations.

Shorter buildings can act as light wells, provide better amenity in local areas of the public domain, and create outlook and views for nearby taller buildings. They can balance areas of more intensive development providing light and air.

### Objectives

- To protect and improve sunlight to important public parks and places throughout the year, during periods in the day when they are most used
- To provide opportunities for additional height on building sites that increase the floor space available for employment uses where they do not overshadow protected spaces
- To protect the character and amenity of public places and streets
- To manage wind effects in public places and streets
- To moderate heights on sensitive sites and areas, such as sites with heritage buildings and within Special Character Areas
- To preserve the heritage values of The Rocks, Millers Point and Chinatown
- To preserve the setting of the Harbour Bridge and Sydney Opera House
- To provide adequate internal amenity for the occupants of towers and neighbouring buildings by promoting:
  - The free movement of air around towers
  - Sunlight to the sides and rear of towers
- To maintain adequate clearance for air navigational activity over and around Central Sydney
- To ensure building towers and their podiums are an appropriate scale and with a mix of land uses that are suitable for the context of a Global City
- To ensure tall buildings do not obstruct important public views
- To ensure that new development is not impeded by the preservation of private views
- To provide podiums that contribute positively to the street wall, defining the public domain at an appropriate scale, and provide active frontages and fine grain retail activity

### Priority actions

- 3.1 Strengthen controls in Sydney LEP 2012 to ensure that tall buildings are suited to their site size and context
- 3.2 Strengthen controls in Sydney LEP 2012 to ensure that tall buildings do not adversely impact the amenity of the City's streets, parks and public spaces
- 3.3 Limit the height of buildings to 55 metres on sites smaller than 1,000 square metres
- 3.4 Provide for an increase in height for some sites along the Western Edge from 80 metres to 110 metres
- 3.5 Strengthen controls in Sydney LEP 2012 to ensure that outlook is protected within the boundaries of a site, rather than private views
- 3.6 Link building heights to setbacks and outlook
- 3.7 Prepare a Height Control Framework which consists of a series of the following building height "overlays" to determine potential building heights in addition to the height controls map
  - Sun Protection Controls (Sun Access Planes and No Additional Overshadowing Controls)
  - Special Character Area Controls
  - View Corridor Controls
  - Heritage Controls
  - Street Frontage Height, Setback and Massing Controls
  - Airports restrictions
- 3.8 Prepare a guideline to allow additional height for employment related development where there is no additional overshadowing of protected places

### Other actions

- 3.9 Develop publicly accessible digital tools for determining the permissible maximum building height on land where development may cause additional overshadowing to an identified protected park or place

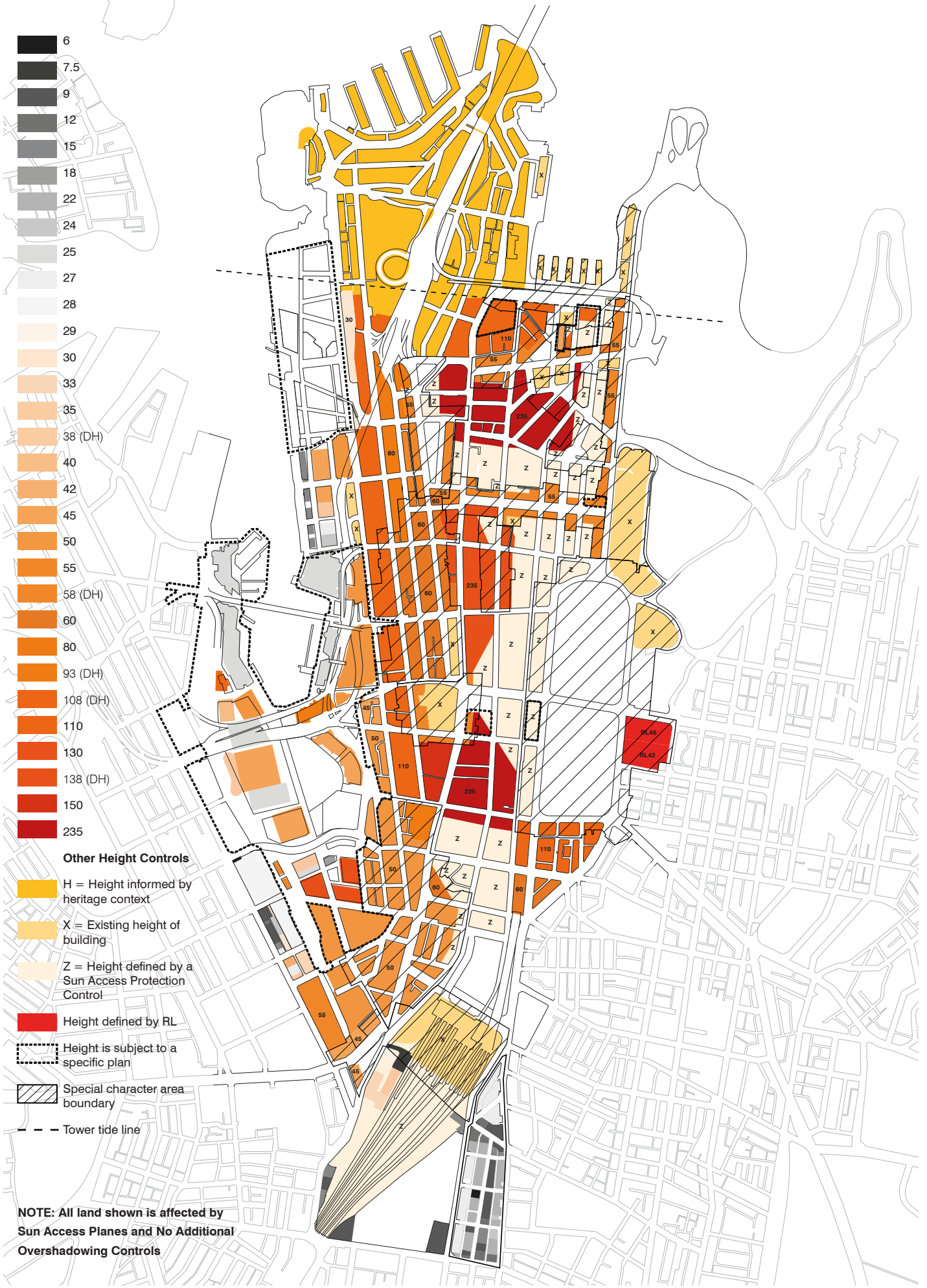

## 04 | Sun protection controls

Two control mechanisms limit heights in Central Sydney to protect sunlight access to important public parks and places. They are Sun Access Planes (SAP) and No Additional Overshadowing to Certain Public Places Controls (NAO). These are the most important height controls that apply to Central Sydney.

SAP and NAO controls establish both dates and time periods to protect spaces. Generally, the times for protection are in the middle of the day when the majority of use occurs and the space is most valued by its users.

Direct sunlight access to important parks and places is important throughout the year. The dates used to generate these controls are set at the most conservative sun angles, which ensures protection throughout the remainder of the year when the sun is higher in the sky.

The dates and times of protection vary for each place according to the type of activities occurring in that place that benefits from sunlight, when those activities are likely to occur, and existing levels of sunlight and overshadowing.

### Sun Access Planes

Sun Access Planes are an arrangement of planar surfaces that is set at the same angle as the sun at specific dates and times and sets the upper building height. Different Sun Access Planes protect a range of public places throughout Central Sydney.

#### Objectives

- To protect and improve sunlight to important public parks and places throughout the year, and during periods in the day when they are most used
- To ensure the healthy growth of trees, grass and other vegetation
- To ensure that all parks and places potentially overshadowed by tall buildings in Central Sydney are protected by Sun Access Planes, including parks that may lie outside the Central Sydney boundary
- To protect sunlight to parks on the eastern edge of the city through the morning and midday period
- To protect sunlight to parks on the western edge of the city from midday through to the afternoon
- To ensure that sunlight to new and planned future important public parks and places are protected by Sun Access Planes or No Additional Overshadowing Controls

#### Priority actions: Sun Access Planes

- 4.1 Revise and update Sun Access Plane controls in Sydney LEP 2012 to improve accuracy and levels of protection of important public places
- 4.2 Introduce controls in Sydney LEP 2012 that will protect significant, new and planned public places that require protection as Central Sydney grows
- 4.3 Remove the "Category A/B" system from Sydney LEP 2012 which allows exceptions to sun access planes
- 4.4 Revise controls in Sydney LEP 2012 to ensure that the following important parks and places are protected by Sun Access Planes with the intended periods of protection, at the dates and times listed (refer to 4\_16)

#### Other actions

- 4.5 Implement new controls to manage breaks to Sun Access Planes
- 4.6 Consider additional of sun access planes in Sydney LEP 2012 to define upper height limits on sites where Strategic Floor Space is available (refer to 4\_17)

### No Additional Overshadowing

No Additional Overshadowing controls protect the existing sunlight to public places already surrounded by tall development. In contrast to Sun Access Planes, No Additional Overshadowing controls preserve sunlight that passes through gaps between buildings to reach public spaces.

#### Objectives

- To protect and maintain sunlight to valued public places that are primarily used as areas for passive recreation by the workforce, visitors and the wider community

#### Priority actions

- 4.7 Protect significant, new and planned public places that require protection as Central Sydney grows
- 4.8 Continue to protect important public places subject to No Additional Overshadowing controls in Sydney LEP 2012 except in cases where the controls provide negligible benefit
- 4.9 Include provisions in Sydney LEP 2012 to ensure that following important public places are protected by No Additional Overshadowing controls during the dates and times listed (refer to 4\_19)

#### Other actions

- 4.10 Consider the addition of the following important public places to be protected by NAO controls all year and at all times (refer to 4\_20)

**4\_10**

Step 1 - The extent of the space to be protected is defined

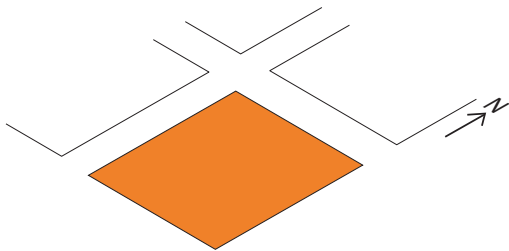

**4\_11**

Step 2 - Alignment of base edge established as a continuous line

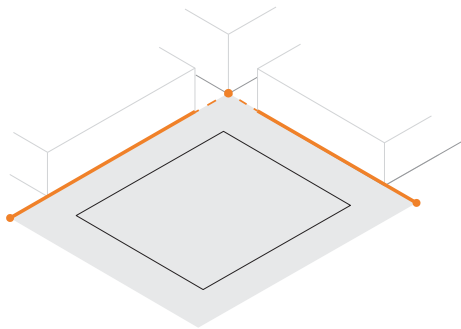

**4\_12**

Step 3 - The base edge is elevated

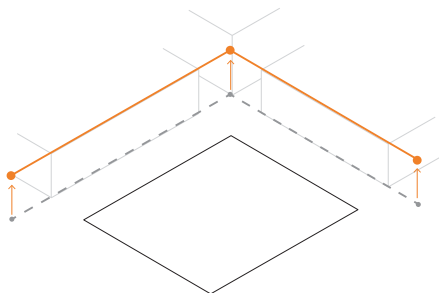

**4\_13**

Step 4 - The base edge is projected at the appropriate solar altitude and azimuth angles to create a plane

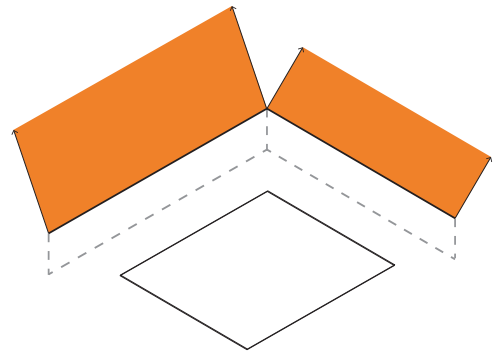

**4\_14**

Step 5 - triangular plane created to generate a fully connected SAP

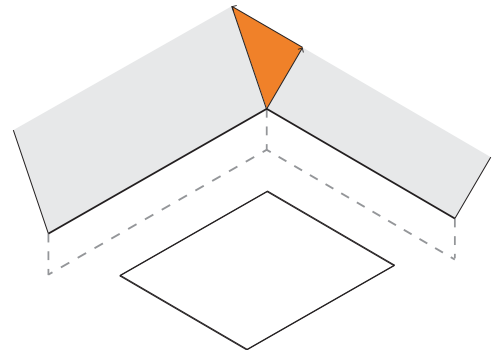

**4\_15**

Step 6 - Equinox and solstice 'tails' are added

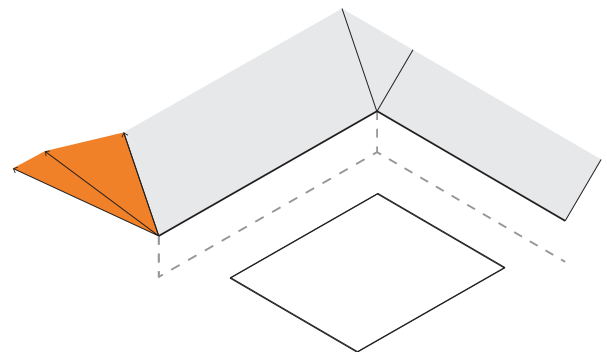

**4\_16**

Periods of protection, times and dates of Sun Access Planes

All times are solar times

|    | Park or Place             | Intended period of protection | Intended times of protection | Appendix M Reference |
|----|---------------------------|-------------------------------|------------------------------|----------------------|
| 1  | The Royal Botanic Gardens | All year                      | 9am–2pm                      | M_01                 |
| 2  | The Domain                | All year                      | 9am–2pm                      | M_02                 |
| 3  | Wynyard Park              | All year                      | 12pm–2pm                     | M_03                 |
| 4  | Lang Park                 | All year                      | 12pm–2pm                     | M_04                 |
| 5  | Hyde Park                 | All year                      | 10am–2pm                     | M_05 and M_06        |
| 6  | Belmore Park              | All year                      | 10am–2pm                     | M_07                 |
| 7  | Prince Alfred Park        | All year                      | 10am–2pm                     | M_08 and M_09        |
| 8  | Harmony Park              | All year                      | 10am–2pm                     | M_10                 |
| 9  | Macquarie Place           | Outside the winter months     | 10am–12pm                    | M_12                 |
| 10 | Martin Place              | Outside the winter months     | 12pm–2pm                     | M_13                 |

**4\_17**

Periods of protection, additional Sun Access Planes



All times are solar times

Additional Sun Access Planes constructed to define upper height limits on sites where Strategic Floor Space is available:

|    |                                      |          |           |      |
|----|--------------------------------------|----------|-----------|------|
| 11 | Barangaroo South “Northern parkland” | All year | 12pm–2pm  | M_14 |
| 12 | Darling Harbour                      | All year | 11am–5pm  | M_15 |
| 13 | Darling Harbour Live Park            | All year | 12pm–2pm  | M_16 |
| 14 | Central Park                         | All year | 12pm–2pm  | M_17 |
| 15 | Railway Square                       | All year | 11am–12pm | M_18 |

4\_18

Spaces protected by Sun Access Planes

-  Parks and spaces protected by Sun Access Planes
-  Additional Sun Access Planes constructed to define upper limits on sites where Strategic Floor Space is available

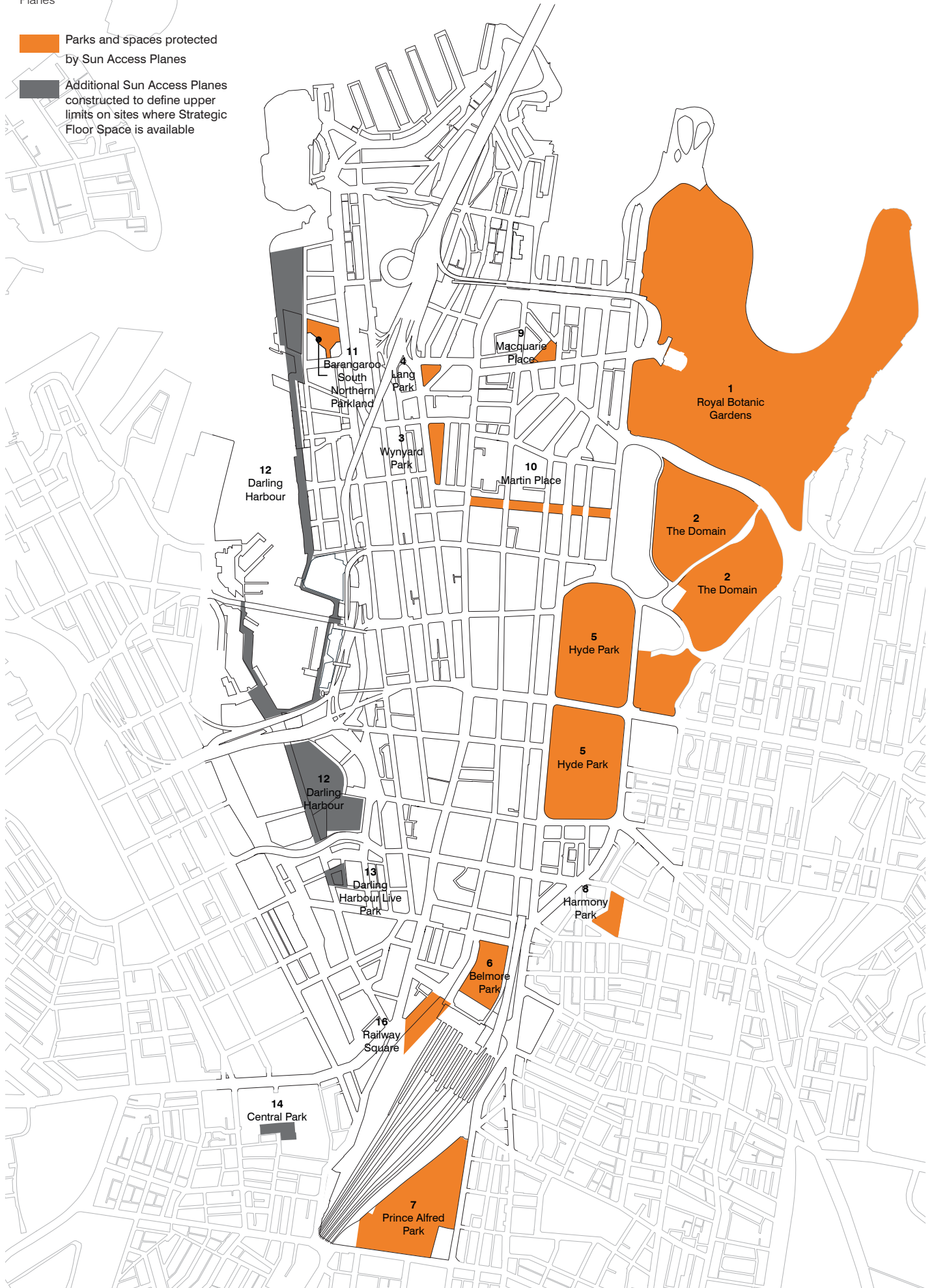

#### 4\_19

Times and Dates for No Additional Overshadowing Protected Spaces

All times are solar times

|   | Park or place                           | Intended period of protection | Intended times of protection | Appendix M Reference |
|---|---|-------------------------------|------------------------------|----------------------|
| 1 | Macquarie Place                         | 14 April – 31 August          | 10am–2pm                     | M_27                 |
| 2 | Martin Place (block containing the GPO) | 14 April – 31 August          | 12pm–2pm                     | M_28                 |
| 3 | Pitt Street Mall                        | 14 April – 31 August          | 10am–2pm                     | M_29                 |
| 4 | Australia Square                        | 14 April – 31 August          | 12pm–2pm                     | M_30                 |
| 5 | First Government House Place            | 14 April – 31 August          | 10am–2pm                     | M_31                 |
| 6 | Sydney Town Hall Steps                  | 14 April – 31 August          | 10.30am–4pm                  | M_32                 |
| 7 | Sydney Square                           | 14 April – 31 August          | 11am–4pm                     | M_33                 |
| 8 | Future Town Hall Square                 | All year                      | 12pm to sunset               | M_34                 |

#### 4\_20

Times and Dates for No Additional Overshadowing Protected Places

All times are solar times

Additional NAO protected places:

|    |  |          |              |   |
|----|--|----------|--------------|---|
| 9  | Observatory Hill   | All year | At all times | – |
| 10 | Barangaroo Headland Park                                 | All year | At all times | – |
| 11 | Circular Quay (including Bennelong Point to Dawes Point) | All year | At all times | – |
| 12 | Walsh Bay Promenade                                      | All year | At all times | – |



4\_21

Spaces protected by No Additional Overshadowing Controls

- NAO Protected Space
- Additional Sun Access Planes constructed to define upper limits on sites where strategic Floor Space is available



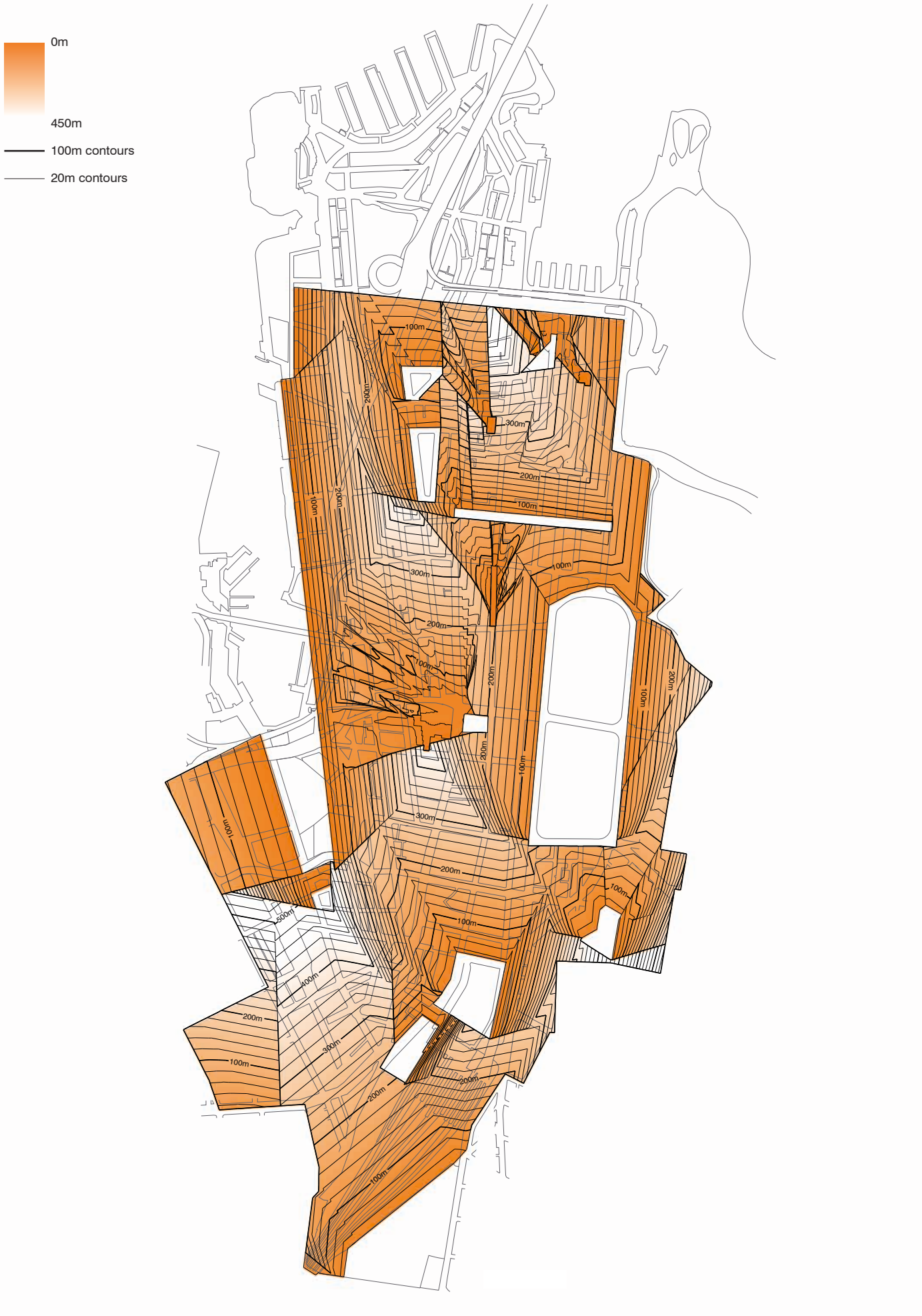

4\_23

Sun Protection Controls Heights Map - including Airport PANS OPS heights (RLs AHD)

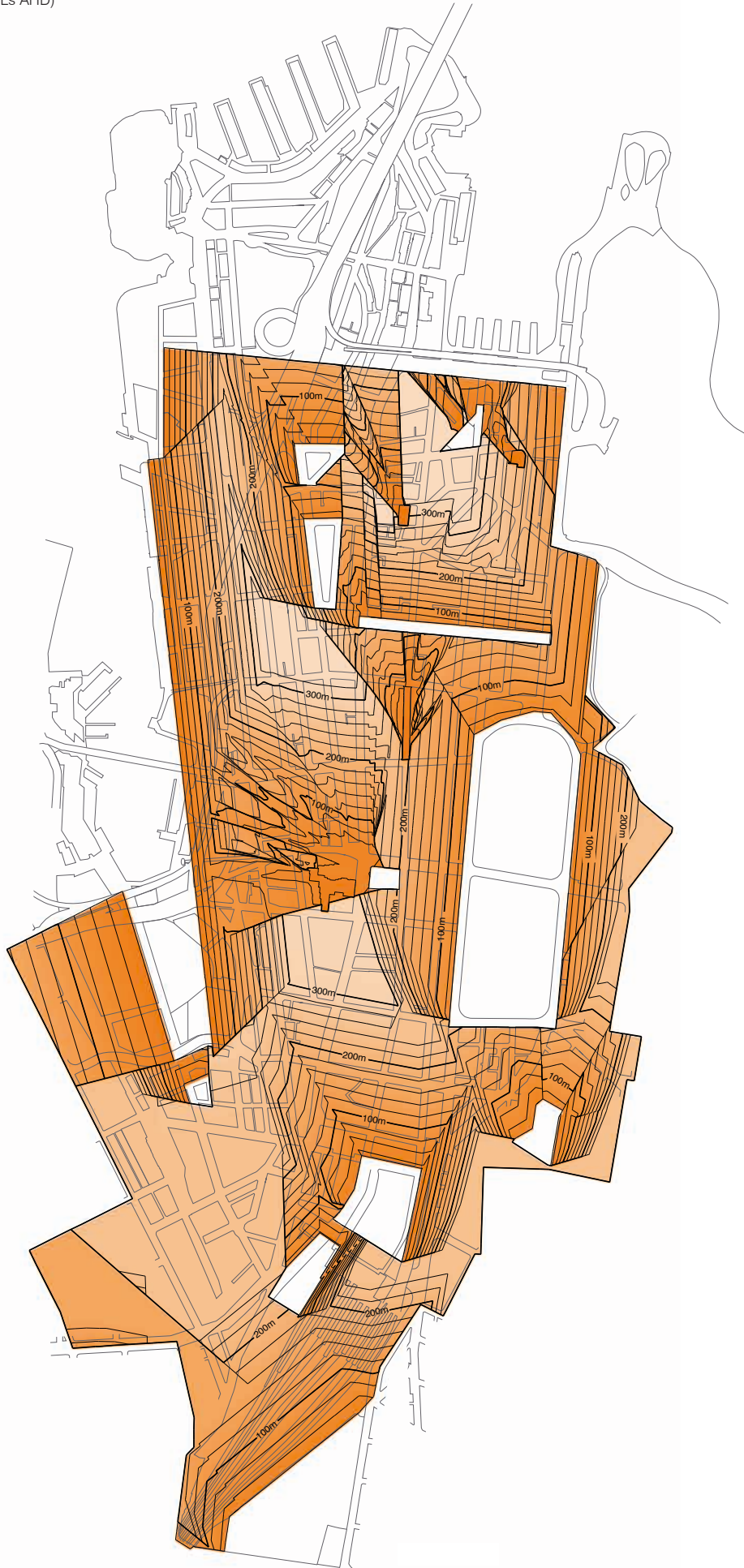
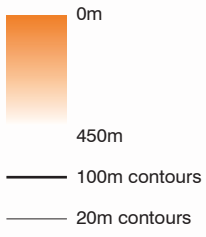

## 05 | Public views

There are a number of key views within Central Sydney, to and through parks and other well-used public spaces, that help define Sydney. Examples of significant views include:

- Views toward Central Station clock tower: these are significant due to the tower's historically physical prominence in the city's landscape.
- Views along Martin Place: These are important due to Martin Place's significance as a gathering place.
- Views to and from Observatory Hill: These are significant due to Observatory Hill's strategic role in the city's history, in milling, defence, communications, astronomy and time keeping. These functions have required the surrounding views and visual alignments to remain open. Observatory Hill's physical prominence relative to city development should be maintained.

New development must be designed to make a positive contribution to the characteristics and composition of designated public views. These public views should be preserved and have priority over private views.

### Objectives

- To identify and preserve significant views from public places

### Priority Action

- 5.1 Identify and map significant views from public places and construct view planes to preserve and protect the following views:
  1. View and silhouette of Central Station Clock Tower
  2. View of western sky looking from Martin Place
  3. View and silhouette of Sydney GPO clock tower looking from Martin Place
  4. View and silhouette of Sydney Hospital looking from Martin Place
  5. View of the harbour from Observatory Hill
  6. View of Macquarie Lighthouse looking from Observatory Hill
  7. View of the horizon between Thompson's Corner and Observatory Park, Pennant Hills, looking from Observatory Hill
- 5.2 Identify public views along streets and require development to respond positively as a backdrop to them
- 5.3 Encourage opening of new views from the city to the harbor and foreshore

View protection planes and Sydney Harbour views

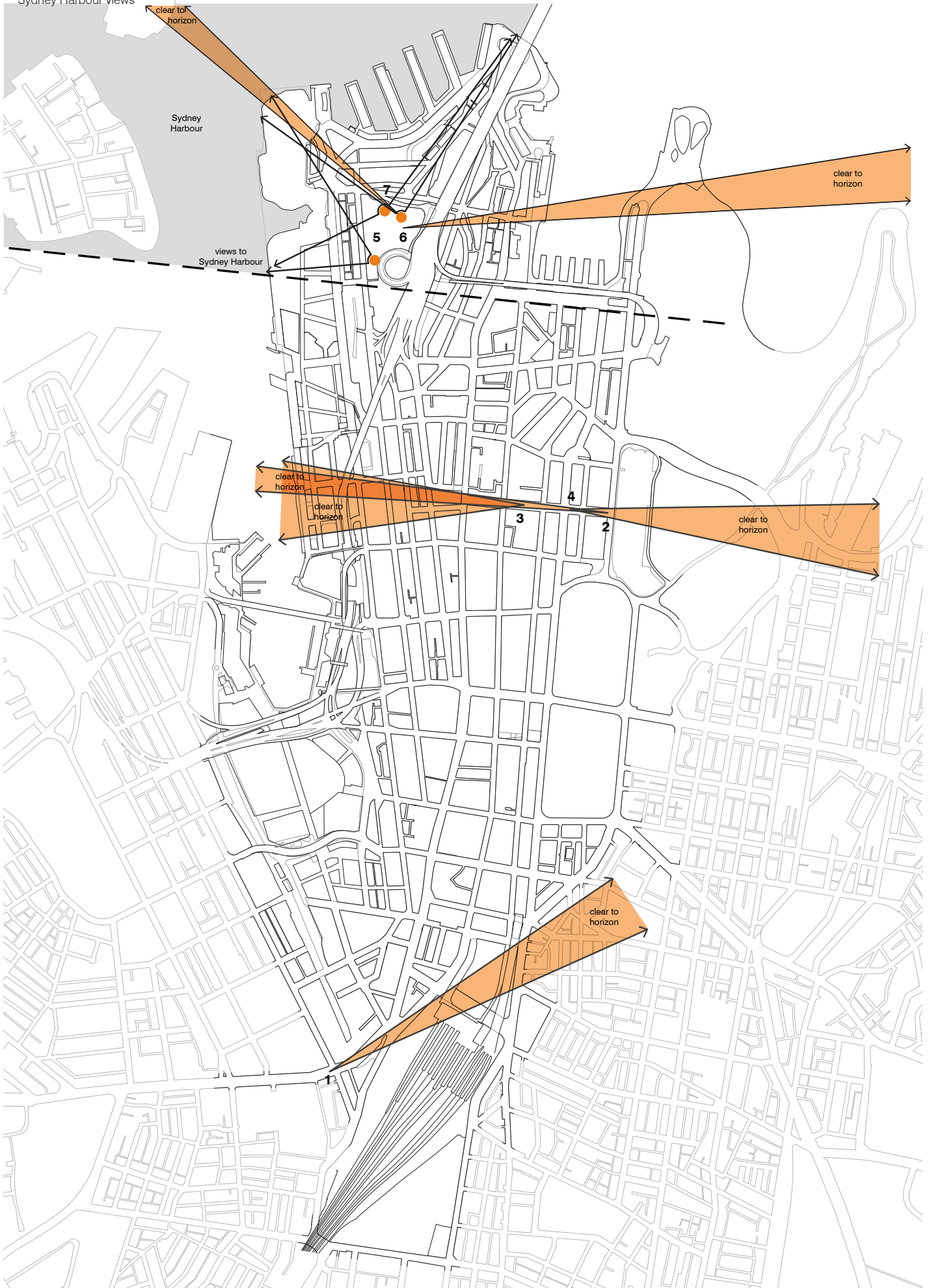

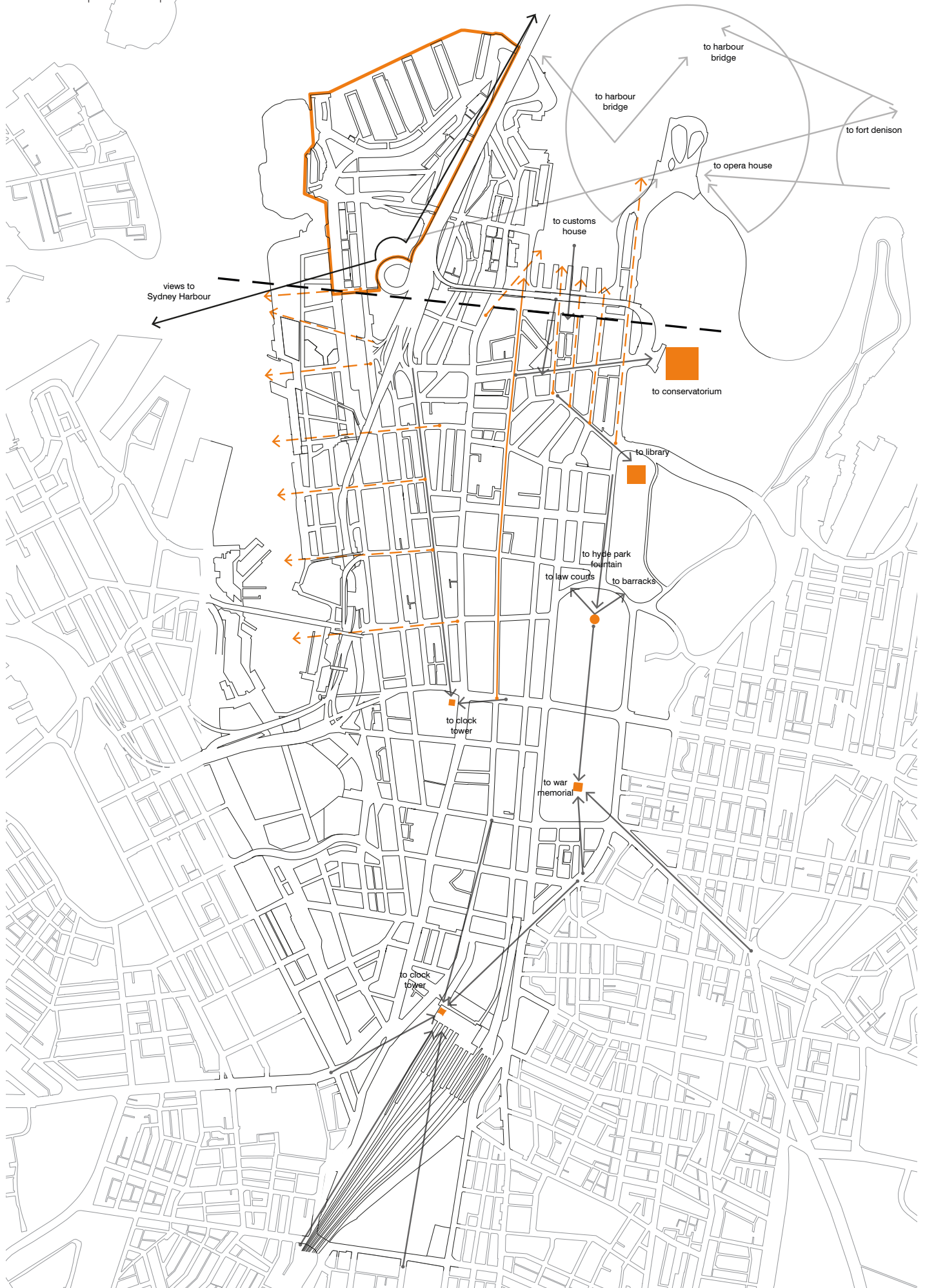

## 06 | Design excellence

Competitive design processes and the concept of design excellence are already well-established in Central Sydney. Central Sydney is a very complex and intensely developed environment. In this context highly integrated analysis is necessary to deliver the highest standard of architectural, urban and landscape design.

As development projects become more complex, design approaches to problem solving provide a systematic way to understand and manage these high levels of complexity. More integrated design approaches to design excellence will be necessary as Central Sydney continues to grow.

### Objectives

- To strengthen the City of Sydney's competitive design processes
- To deliver projects that achieve the highest standard of design excellence
- To ensure that planning, urban design, architecture, landscape architecture, infrastructure, the public domain, landscape, utility and aesthetics are all key determinants of design excellence and have input into the design process from the initial feasibility/master planning phase through to project completion
- To recognise that design excellence requires a creative, iterative and multidisciplinary approach
- To ensure that the design excellence process provides outcomes that balance public and private interests
- To ensure the sum of design excellence outcomes creates an environment to support the most livable, diverse, vibrant and sustainable city for its people
- To increase awareness of the value of good design
- To support the development of professional capability to deliver design excellence
- To support the long term economic sustainability of the professions that deliver design excellence
- To drive continual improvement in design outcomes
- To ensure developments are delivered and maintained to approved design excellence standards
- To maintain and uphold the highest quality of jury expertise

### Priority actions

- 6.1 Encourage a design-led iterative process between proponent and the Consent Authority to be used to maximise strategic floor space prior to the lodgement of a Planning Proposal
- 6.2 Establish a prequalified list of highly experienced jurors to judge significant sites
- 6.3 Ensure the highest level of design skill is leveraged through the competitive process for sites in Central Sydney
- 6.4 Encourage a co-operative process between proponent and Consent Authority post-competition for sites where very complex and/or unusually technical constraints require an integrated approach

- 6.5 Enhance the design integrity requirements to ensure the design excellence qualities of the winning scheme are maintained or improved on throughout design development, application lodgement, application amendments and completion of the project

### Other actions

- 6.6 Encourage use of design processes and options testing in early stages of strategic planning and master planning prior to the lodgement of a detailed Development Application or Planning Proposal
- 6.7 Celebrate excellent design outcomes to build public dialogue and awareness of the value of design by encouraging:
  - Public talks
  - Exhibitions and the publishing of design competition processes and outcomes
  - The establishment of awards for best design competition outcomes
- 6.8 Collaborate and leverage shared resources with industry bodies to disseminate a consistent understanding of design excellence, to include RAlA, Landscape Institute, PIA and Property Council
- 6.9 Encourage industry bodies to initiate professional development courses focused on design excellence processes to build capability of future competition participants
- 6.10 Implement processes that ensure developments are delivered and maintained to approved design excellence standards
- 6.11 Review the City's Competitive Design Policy periodically to ensure continuous process innovation and improvement
- 6.12 Establish and uphold a consistent understanding of design excellence across Local and State Government to ensure consistency and integration across the two tiers of government
- 6.13 Lend support in streamlining competition management processes by sharing knowledge and providing guidelines and template systems
- 6.14 Support research on design excellence and knowledge sharing between research institutions and industry bodies
- 6.15 Sustain and expand the field of registered Architects participating in competitions to achieve better outcomes through various processes including encouraging the use of open competitions and encouraging partnerships between emerging design practices and established firms
- 6.16 Develop criteria for determining significant sites requiring a prequalified jury

## 07 | General built form controls

The predominant typology of Central Sydney's built form is a consistent street wall, with tall buildings and towers set back above the street wall. This configuration manages impacts on the amenity of the public domain and surrounding development. Elements will perform in the following ways:

- **A tower** that is set back from its site boundaries and sits on a building podium creates a space around it that provides light and air into the street
- **A building podium** maintains definition of the street at a reasonable scale while managing the climatic effects of tall buildings including downdrafts, wind funnelling, reducing daylight and overshadowing
- **Street walls** establish areas of special character throughout Central Sydney as a result of variations in their scale and articulation
- **Heritage items** create space between towers that allow more sunlight, daylight and air to reach the street

Issues of scale, daylight, wind and character arising from tall buildings can be managed by controlling:

- Street frontage heights
- Setbacks
- Building separations
- Maximum tower area and dimensions

### Objectives

- To maintain daylight and sunlight in streets, lanes and public places
- To manage the wind impacts of development on streets, lanes and public places so that they are safe and comfortable for people
- To allow air movement to disperse pollution and to cool streets, lanes and public places
- To ensure that occupants of tall buildings have access to daylight and outlook by providing good separation from site boundaries (and surrounding buildings as a result)
- To ensure small sites that are unable to provide setbacks do not develop as towers
- To establish street wall heights in Central Sydney appropriate to context and location
- To ensure that tall buildings are designed to be seen from all sides
- To promote streets and laneways as important public places
- To ensure adequate setbacks, separations and articulation are provided to maintain a layered edge of towers on the perimeter of Central Sydney

### Priority actions

- 7.1 Stipulate street frontage heights, street setbacks, and side and rear setbacks to ensure that tall buildings develop as a tower on a podium form ensuring amenity in public places
- 7.2 Incorporate a system for variation to street frontage height and street frontage setback controls to allow a reasonable amount of flexibility while maintaining amenity in public places
- 7.3 Set minimum outlook controls
- 7.4 Maintain light and air by generally not allowing, and in special circumstances, carefully managing, the development of tall buildings over heritage items



**4\_26**

Historical street wall pattern of development

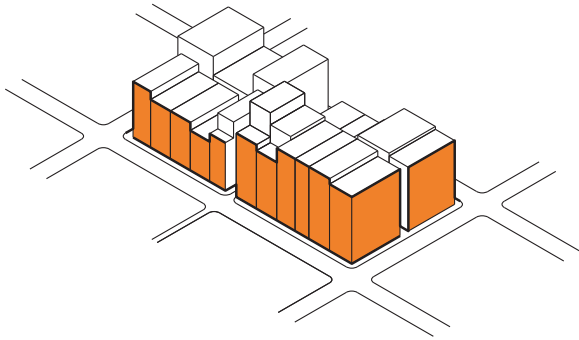

**4\_27**

Example of tower form without podium (typical of the Modern period)

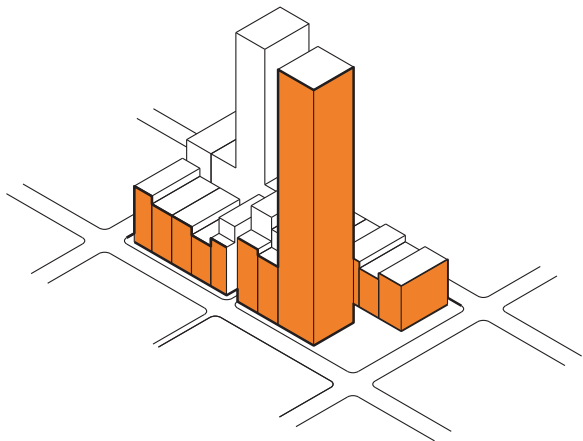

**4\_28**

Preferred tower and podium typology

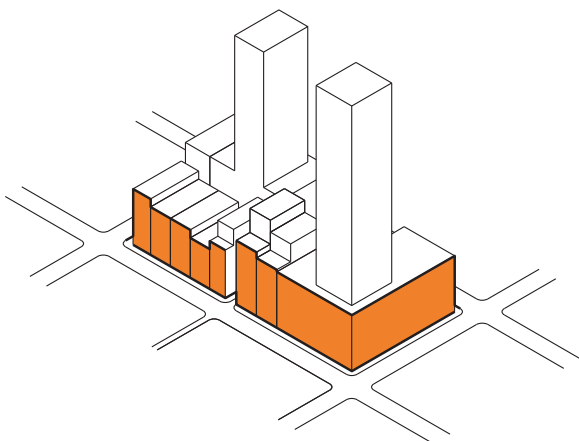

**4\_29**

Tower building with no streetwall setback results in limited sky view

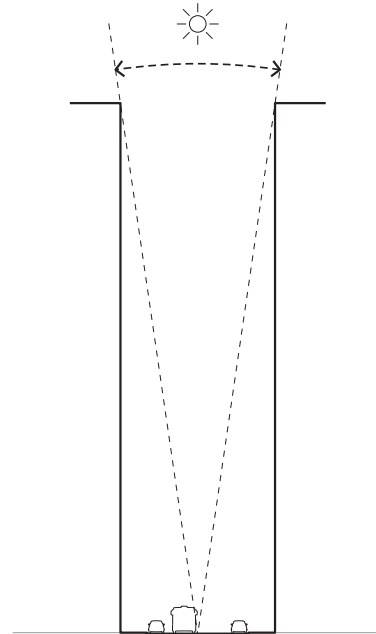

**4\_30**

Tower setback from podium streetwall increases skyview

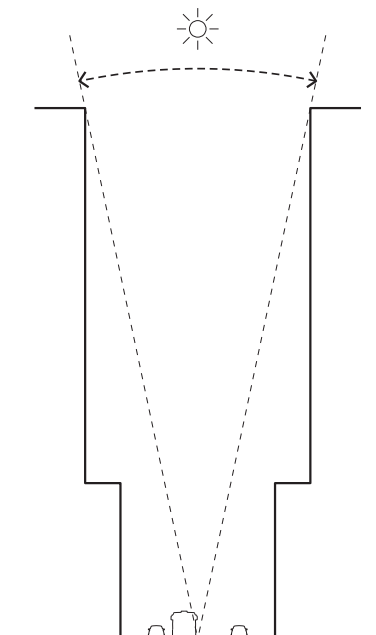

## 08 | Street frontage height and street setbacks

Street frontage height and street setbacks influence public amenity and contribute to the enjoyment of Central Sydney's public places.

### Objectives

- To define streets in Central Sydney with consistent building edges at the street frontage to an appropriate height that provides a comfortable scale, interesting character, and environmental safety for pedestrians
- To recognise the variety and patterns of street wall heights throughout Central Sydney
- To link street frontage heights to building height
- To ensure that buildings address and define laneways consistent with their special character
- To provide setbacks above the street frontage to promote good primary separation between towers across streets, and maintain daylight, views to the sky and a sense of openness in the street
- To promote visually interesting street wall facades
- To protect long, low views of open sky and landmark features

### Priority actions

- 8.1 Ensure new development is consistent with street frontage height and street setback provisions
- 8.2 Provide clear, measurable tests for the variation of street frontage height and street setback controls

### Other actions

- 8.3 Ensure street frontage heights of new development respond to Special Character Areas and overall building height and width of adjacent streets and lanes (refer to 4\_31)
- 8.4 Maintain street setbacks of 8m for all streets and lanes and ensure setbacks extend for the full height of the building above the street wall and are fully open to the sky, without any obstruction
- 8.5 Allow variation to street setbacks based on an encroachment within the middle third of the frontage and compensating recess framework or through modelling of equivalent daylight and wind conditions in the public domain

## 09 | Side and rear setbacks, separation and outlook

Setback and separation between tall buildings allows for sunlight in public places and for ventilation of city streets. Providing outlook for future occupants provides for future occupant amenity and ensures developments do not borrow amenity from adjoining sites.

### Objectives

- To ensure tower forms are appropriately set back from side and rear boundaries to:
  - Allow sufficient light and air into the street
  - Provide outlook to building occupants
  - Provide definition to building podiums
  - Ensure that tower forms appear “in the round”
- To ensure self-sufficiency of towers so that they have enough space around them to provide for light, air and outlook entirely within the site area
- To avoid the appearance of a contiguous “wall of towers”, where groups of tall buildings appear as one solid mass
- To promote separate building forms that create a layered visual effect when viewed from a distance

### Priority actions

- 9.1 Ensure new development is consistent with side and rear setback provisions
- 9.2 Ensure new development is consistent with outlook provisions
- 9.3 Ensure provisions are consistent with SEPP 65 and Apartment Design Guide requirements for residential apartment and serviced apartment buildings

### Other actions

- 9.4 Ensure side and rear setbacks provided within the site boundaries are not less than 3.33 per cent of the height of the building or 4m whichever is greater to a maximum of 8m to provide light and air to public places. The required setback should be consistent for the full height of the building above the street frontage height
- 9.5 Allow variation to side and rear setbacks through modelling of equivalent daylight and wind conditions in the public domain
- 9.6 Ensure all windows and balconies have sufficient outlook provided within the site boundaries and adjacent public places generally within a 90-degree conical field extending from the window/balcony with the following minimum dimensions (refer to 4\_32)
- 9.7 Side and rear setbacks and outlook are measured from the site boundary and do not include easements, setbacks or heritage items on adjacent sites

#### 4\_31

##### Street Frontage Height

Ensure street frontage heights of new development respond to overall building height and width of adjacent streets and lanes

| Range of Street Frontage Heights | Proposed total height of building  |                             |                   |
|----------------------------------|--|-----------------------------|-------------------|
|                                  | Up to 55m  | Greater than 55m up to 120m | Greater than 120m |
| Frontage to a street             | 20–35m*<br>Or 20–45 for street block corner sites less than 1000m <sup>2</sup> | 20–35m*                     | 20–25m*           |
| Frontage to a lane               | 20–45m   | 20–45m                      | 20–25m*           |

\* Allow street frontage height to increase up to 45m for some classes of buildings to accommodate commercial floor space

#### 4\_32

##### Outlook

Ensure all windows and balconies have sufficient outlook provided within the site boundaries and adjacent public places generally within a 90 degree conical field extending from the window/balcony with the following minimum dimensions

| Minimum Outlook Field depths   |  | Window or balcony height above ground |               |               |                 |       |
|--|--|---------------------------------------|---------------|---------------|-----------------|-------|
|  |  | Up to 12m                             | >12 up to 25m | >25 up to 45m | >45m up to 120m | >120m |
| Residential, serviced apartments and other forms of self-contained accommodation | Primary windows to living spaces and associated balconies  | 6m                                    | 9m            | 12m           |                 |       |
|  | Other windows or balconies   | 6m                                    |               | 9m            |                 |       |
| All other forms of accommodation (e.g. non self-contained hotel rooms)           | All windows and balconies  | 6m*                                   |               |               | 9m              |       |
| All uses not covered elsewhere in this table                                     | Balconies and windows to areas other than common circulation spaces windows to common circulation spaces | 3m*                                   |               |               | 6m              | 9m    |
|  | Windows to common circulation spaces   | 3m*                                   |               |               |                 |       |

\* Windows and balconies may be built to any site boundary adjacent to a Public Place up to the Street Frontage Height

## 10 | Built form massing – tapering and maximum dimensions

A lightness of form is important to the overall shape of a city. Buildings that are massive and bulky can create a feeling of oppressiveness, blocking sunlight and views.

### Objectives

- Ensure that buildings are slimmest at their peaks, so that in the overall city form, buildings are perceived as less bulky

### Actions

- 10.1 Ensure new development is consistent with provisions regulating maximum tower dimensions, street overhangs and building tapering

## 11 | Heritage

Central Sydney contains many very significant and unique buildings and areas significant not only locally but for the state and nation. The dispersed locations of heritage items throughout Central Sydney provides variety of height and character to the otherwise very high continuous street walls. The community places high value on these items and areas; planning controls have evolved that protect them.

Heritage planning aims to ensure that significant elements of the past are appropriately managed and respected by new development. Heritage conservation does not preclude change but rather responds to constraints and opportunities offered by heritage buildings and areas. Changes should respect the heritage significance of the item or area, including associated settings, views and “fabric”, the physical material of a place including its surroundings and contents.

### Objectives

- To ensure that heritage significance is considered for heritage items and development affecting archaeological sites and places of Aboriginal heritage significance, including associated fabric, settings and views
- To enhance the character and heritage significance of heritage items
- To ensure that new development is designed to respond positively to the heritage character of adjoining and nearby buildings and features of the public domain.
- To maintain the curtilage of heritage items and daylight to adjacent public places

### Actions

- 11.1 Undertake a site-by-site analysis to determine whether to allow vertical additions to or development above each heritage item
- 11.2 Require careful consideration of heritage value before permitting vertical additions to or development above heritage items

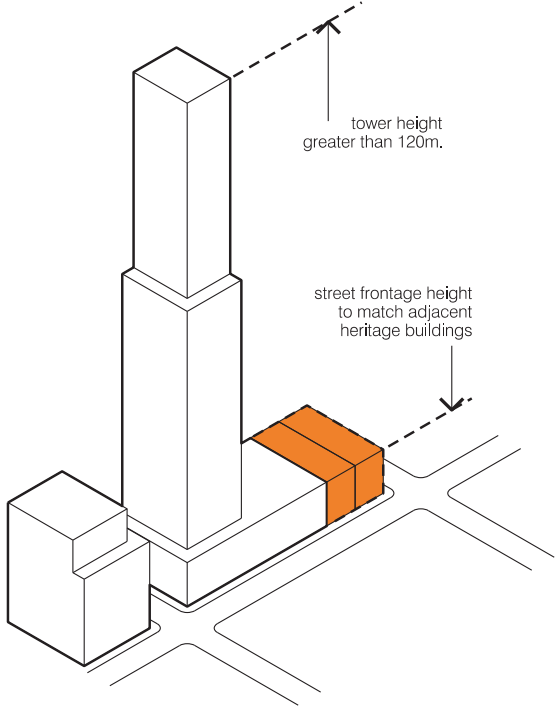
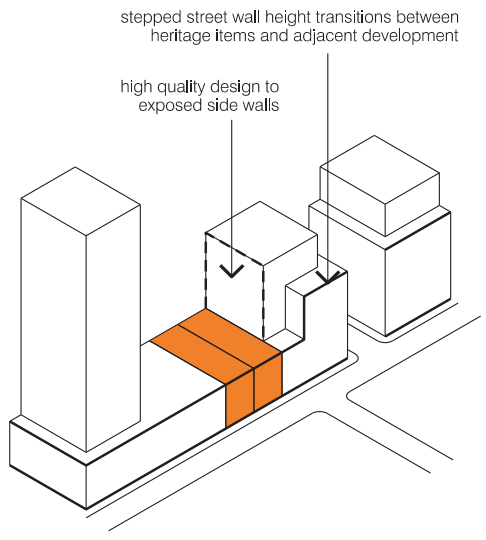
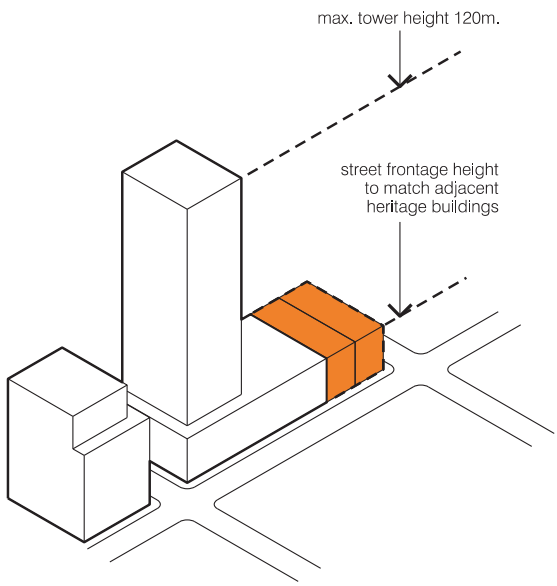
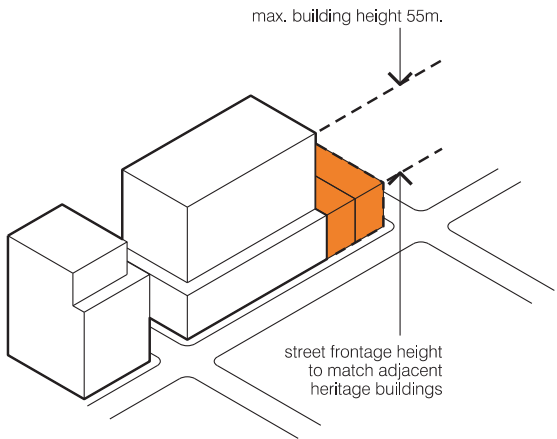

## 12 | Special Character Areas

Central Sydney contains a number of areas with special and distinctive character that the community consider to be of significance and that are important to the identity and character of Central Sydney: these are called “Special Character Areas”.

These areas include a number of distinctive qualities: a character unmatched elsewhere in Central Sydney; a concentration of heritage items and streetscapes; high cultural significance and a focus on public life. In addition, they often include a highly distinctive element in the public domain or are centred around a significant park or other public space.

### Objectives

- To retain and enhance the unique character of Special Character Areas
- To ensure development has regard to the fabric and character of Special Character Areas in scale, proportion, street alignment, materials and finishes
- To reinforce the distinctive attributes and qualities of buildings in Special Character Areas
- To conserve and protect heritage items and their settings
- To maintain a high level of sunlight and daylight access to streets, lanes, parks and other public domain spaces
- To conserve, maintain and enhance existing views and vistas to buildings and places of historic and aesthetic significance

### Actions

- 12.1 Provide clear guidance about permissible heights and setbacks in Special Character Areas by way of detailed Special Character Area Maps
- 12.2 Provide clear guidance where higher heights will not be considered to preserve the character and significance of Special Character Areas
- 12.3 Clarify and update special character area street frontage height and street setback controls consistent with Appendix E Special Character Areas

 Special Character Area boundary

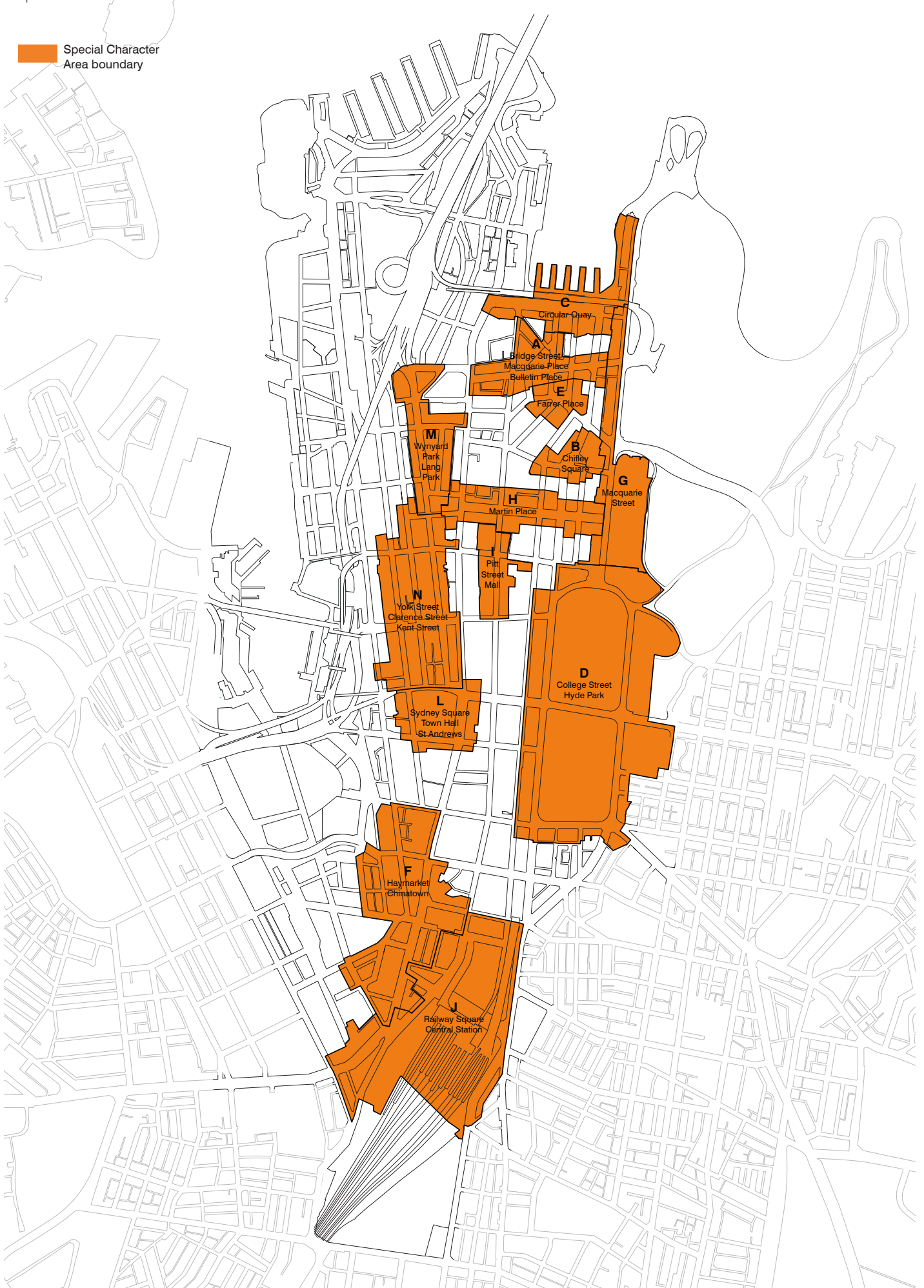

## 13 | Heritage floor space

A transferable heritage floor space scheme to encourage heritage conservation in Central Sydney has been in existence since 1971. It was originally conceived to enable the unrealised development potential of a heritage-listed building to be sold and used elsewhere in Central Sydney where a floor space bonus was available. The transfer is dependent on agreed conservation works being completed and a covenant or similar instrument being placed on the land title of the heritage building extinguishing its development potential.

### Objectives

- To establish a framework for the transfer of development potential from the site of a heritage building to another site
- To provide an incentive for the conservation and ongoing maintenance of heritage buildings
- To ensure the operation of the Heritage Floor Space Scheme does not unreasonably delay the delivery of development
- To promote transparency of the Heritage Floor Space Scheme to provide certainty for proponents

### Actions

- 13.1 Extend the Heritage Floor Space Scheme to expanded Central Sydney areas
- 13.2 Implement an Alternative Heritage Floor Space Allocation Scheme. At the election of the landowner and for a temporary period, allow Council to enter into agreements which may lead to the allocation of Heritage Floor Space being deferred to a specified time or, in the event that Heritage Floor Space cannot be obtained, replaced with an alternative arrangement of equal or greater heritage value
- 13.3 Ensure that the requirement to allocate Heritage Floor Space in respect of accommodation floor space applies only to development that has a building height greater than 55 metres
- 13.4 Consider the need to continue incentivising heritage conservation in Central Sydney
- 13.5 Investigate other means for encouraging and achieving heritage conservation.
- 13.6 Review the Heritage Floor Space Scheme including rates or awards, allocations and projected supply and demand
- 13.6 Consider expanding the transferable floor space scheme to other markets, including ecologically sustainable development upgrades for existing lower-grade office buildings



## 14 | Delivery of infrastructure and affordable housing

New workers, residents and visitors to Central Sydney will increase the demand for a range of infrastructure including transport, parks and squares, affordable housing, cultural facilities, and community and social support services, as well as essential services such as energy, telecommunications, waste and water.

Development contributions collected under Section 61 of the City of Sydney Act 1988 cannot fund all the infrastructure, so fresh approaches are needed to ensure the critical infrastructure needed to support growth in Central Sydney can be provided.

### Objectives

- To ensure that as the number of new workers, residents and visitors in Central Sydney grows, the infrastructure required to support that growth is provided
- To identify funding streams and appropriate planning mechanisms for the delivery of infrastructure

### Priority actions

- 14.1 Introduce an affordable housing contribution framework
- 14.2 Develop contributions framework for planning proposals that seek to increase floor space

### Other actions

- 14.3 Develop a Central Sydney Infrastructure Plan in consultation with the community and with appropriate state government organisations. The Plan is to identify the need for infrastructure in Central Sydney so that it can inform future infrastructure planning
- 14.4 Review the Central Sydney Development Contributions Plan 2013 following the next census
- 14.5 Recognise affordable housing as part of the critical infrastructure that is needed to ensure the economic and socially sustainable growth of Central Sydney
- 14.6 Develop a policy framework for the public to share in the value created by changes to the planning controls as a means of providing the additional infrastructure needed to support the additional growth. Sharing in the value may be via dedicating land or floor space, for example for improved public domain, or via monetary contribution for the provision of infrastructure

## 15 | Pedestrians

Walking is a very important component of access and transport in Central Sydney. The Strategy encourages improving the pedestrian experience in relation to safety, flow, comfort and navigation.

### Objectives

- To ensure pedestrian safety and comfort is provided throughout and into Central Sydney
- To ensure that walking is prioritised
- To increase the permeability of Central Sydney for pedestrians when travelling east–west with equitable and diverse paths of travel provided

### Actions

- 15.1 Produce in partnership with the NSW Government, a pedestrian guidance for Central Sydney that includes Level of Service tools and guidelines for footpath widths, arrangement and design
- 15.2 Collect comprehensive pedestrian movement data and establish a predictive pedestrian model for Central Sydney
- 15.3 Redesign streets and intersections to minimise pedestrian movement restrictions
- 15.4 Improve the pedestrian routes to and from Central Sydney, in particular: through the Domain from Potts Point and along Oxford Street from the east; at the ends of the Pyrmont Bridge from the west, through and around Central Station from the south; and, from the Harbour Bridge in the north, consistent with the City's Walking and Action Plan and Livable Green Network Strategy
- 15.5 Identify street blocks where through site links should be provided in order to increase the permeability of Central Sydney east–west
- 15.6 As the density of workers and residents in Central Sydney increases, improve the quantity and quality of pedestrian space, including: footpaths, pedestrian streets and squares
- 15.7 Increase comfort and level of service at intersections and reduce pedestrian wait times
- 15.8 Extend the coverage of awnings to provide pedestrian shelter from rain, sun and wind
- 15.9 Investigate extension of existing pedestrian streets, for example: Pitt Street between King and Hunter Streets and further extensions to the George Street pedestrian zone
- 15.10 Require consolidation and shared driveway access. Prohibit driveways on streets with intense pedestrian traffic, or where vehicle access will conflict with future public transport corridors
- 15.11 Investigate extending underground pedestrian networks associated with existing and new rail stations
- 15.12 Advocate for transport planning authorities to prioritise pedestrian safety and comfort in decision making regarding Central Sydney

## 16 | Cycling

The Strategy promotes cycling within Central Sydney as a healthy and efficient form of transportation that is sustainable and safe. It aims, where possible, to make Central Sydney a more cyclist-friendly place.

### Objectives

- To promote cycling as a safe and convenient transport choice in Central Sydney

### Actions

- 16.1 Implement the Inner Sydney Regional Bike Plan – finish missing links to inner ring suburbs
- 16.2 Further encourage facilities for bicycle delivery services
- 16.3 Ensure end of trip facilities are available for all cyclists
- 16.4 Investigate the feasibility of public bike hire

## 17 | Public transportation

There are many important developments for Central Sydney relating to public transportation including the introduction of CBD, South East Light Rail and Sydney Metro. Supporting employment growth in Central Sydney will require enormous transformation of public transportation with an integrated approach that considers the use of bus, light rail and heavy and metro rail, how to get between stations and connections and ensure safety for all users.

### Objectives

- To support the improvement and growth of heavy and metro rail in Central Sydney
- To promote the efficient operation of surface public transport (bus and light rail)
- To improve modal interchange and co-locate them with public open space
- To increase safety for all users
- To extend the public transport network around Central Sydney
- To remove bus layovers from Central Sydney
- To reduce bus numbers in Central Sydney

### Actions

- 17.1 Plan for and protect future routes for additional light rail services and combine these with future new pedestrian streets (for example, Elizabeth Street)
- 17.2 Advocate for further public transport connections to the Bays Precinct and areas not currently well served, including the areas north of Parramatta Road
- 17.3 Study long-term solutions that reorganise bus and light rail routes and stops to maximise their efficiency and increase safety while freeing street space for pedestrians. Minimise bus turning to promote safety and minimise layover to save space
- 17.4 Project future potential high-growth pedestrian areas using pedestrian movement data to inform priority projects and precincts
- 17.5 Investigate combining modal interchange with existing and new pedestrian squares. For example: investigate the repurposing the Cahill Expressway as a bus interchange; and, investigate making Park Street, at the new Town Hall Square, a bus-only street and interchange
- 17.6 Promote new stations in the less well-served southern part of Central Sydney
- 17.7 Promote bus/train interchange outside Central Sydney and advocate against projects that will increase bus numbers in Central Sydney

## 18 | Private motor vehicles

Private motor vehicles require more space to move less people than any other transport mode in Central Sydney. Their spatial inefficiency undermines the ability to promote the efficiency, comfort and safety of other modes of transportation.

### Objectives

- To eliminate through traffic from Central Sydney
- To increase safety for the full range of users of the streets in Central Sydney
- To reallocate road space to higher capacity transport modes including walking
- To provide for taxis and other hire vehicles

### Actions

- 18.1 Promote changes to the local street network and new connections within the arterial network to reduce and eventually eliminate through traffic from Central Sydney
- 18.2 Investigate weekly car free hours commencing with areas of highest pedestrian concentration, for example, throughout the shopping precinct during weekend afternoons in peak shopping seasons (i.e. sales and pre-Christmas rush times)
- 18.3 Advocate for cordon charging in Central Sydney or broader road pricing
- 18.4 Investigate progressive introduction of lower traffic speeds throughout Central Sydney to increase safety for all road users

## 19 | Loading and servicing

High-density land uses in Central Sydney generate significant demand for delivery and service vehicles, and their loading and servicing. At the same time, the location of site entries and driveways can have profound impacts on the functioning and character of Central Sydney. Careful management is needed to limit impacts on the traffic network, reduce demand on kerbside loading space and allow the efficient operation of surface public transport.

### Objectives

- To ensure servicing and delivery is convenient while limiting its impacts on other users
- To improve the efficiency of parcel delivery, and reduce impacts on the street network

### Actions

- 19.1 Develop incentives for a precinct-based approach to commercial vehicle management, including the use of innovative open-access loading docks or shared servicing facilities. These will be capable of accommodating demand from new developments, while also serving existing heritage sites and small sites which may not have on-site parking or loading
- 19.2 Create dedicated small delivery consolidation points or incentivise in development] to allow more “last-mile” parcel delivery to be achieved by foot, cargo cycle courier, or electric vehicle.
- 19.3 Encourage self-storage facilities, particularly in retail precincts, to reduce the need for multiple small consignments
- 19.4 Investigate loading on widened footpaths at low pedestrian volume periods, i.e. at night

## 20 | Car parking

Central Sydney now has approximately 50,000 off-street parking spaces, divided between resident parking, tenant parking and publicly accessible parking stations. As Central Sydney and its surrounds grow, the pressures increase of managing street space, including car parking.

### Objectives

- To stabilise and eventually decrease parking supply in Central Sydney
- To minimise conflict with pedestrians by consolidating site access

### Actions

- 20.1 Investigate planning and market mechanisms to limit total parking supply while facilitating the retirement and/or transfer of some existing parking supply to new development sites
- 20.2 Require consolidation and shared driveway access.
- 20.3 Prohibit driveways on streets with intense pedestrian traffic, or where vehicle access will conflict with future public transport corridors
- 20.4 Where significant access consolidation is proposed, consider innovative solutions, including the connection of basement levels beneath existing public streets

## 21 | Streets, lanes and footpaths

The physical environment of Central Sydney's streets makes an important contribution to Sydney's profile as a Global City. High-quality street design aligns with the strategy to attract high-productivity workers.

Public streets, laneways and footpaths provide permanent pedestrian and vehicle connections through the city at all hours. A hierarchy of streets and lanes articulate the urban grain, provide permeability of movement and define vistas and views within and beyond Central Sydney. In Sydney, the alignment of streets often expresses the topographic and landscape structure of the city.

Pedestrians should be offered opportunities to walk through the City at the ground level with comfort and ease to promote a lively and safe public domain.

Pedestrian and bike networks increase opportunities for people to move around, maintain or improve their health and reduce the environmental and economic impacts of congestion caused by private car use.

Pedestrian overpasses are discouraged because they enclose public space and block views along streets and reduce daylight. For these reasons, new pedestrian underpasses should not be considered.

### Objectives

- To ensure the street environment of Central Sydney achieves excellence in design and amenity as appropriate for a Global City
- To maximise the efficiency of transport through the comprehensive, integrated design of streets
- To ensure that streets prioritise pedestrians, cycling and transit use
- To create new connections between streets
- To retain and enhance laneways
- To maximise street life
- To minimise obstructions to views and vistas along streets

### Actions

- 21.1 Redesign streets with high-quality finishes, furniture and fittings particularly focusing on the southern areas of Central Sydney
- 21.2 Research, understand and incorporate innovations in streets from elsewhere in the world
- 21.3 Plan for improved connections to the western waterfront with diverse, alternate and equitable paths of travel provided
- 21.4 Increase and improve tree planting
- 21.5 Declutter streets by removing unnecessary elements, like bollards, and by considering how necessary public elements in streets, such as public toilets, information kiosks and furniture storage, can be provided for on private land
- 21.6 Ensure private developments incorporate space at ground level for appropriate pedestrian circulation at entries, while ensuring active frontages

- 21.7 Improve wayfinding
- 21.8 Ensure clear footpath widths are maximised
- 21.9 Ensure streets are designed to include footpath extensions at intersections
- 21.10 Identify areas of high pedestrian activity where loading is to be provided on footpath outside peak pedestrian periods during the week (e.g. Pitt Street)
- 21.11 Provide designs that naturally calm traffic speeds to a maximum of 30 kilometres per hour on local streets and 10 kilometres per hour on laneways
- 21.12 Retain existing public and private laneways
- 21.13 Prohibit bridges and projections other than awnings over streets and lanes which overshadow them or obstruct views
- 21.14 Ensure development adjacent to lanes:
  - Includes active uses at ground level to encourage pedestrian activity
  - Enhances pedestrian access and activity
  - Avoids bridges and projections over lanes which overshadow the lane, obstruct a view or vista or impede pedestrian activity at ground level
  - Provides access for service vehicles only as necessary and manage any conflict with pedestrian functions
- 21.15 Provide new underpasses to directly connect from adjacent streets to public transport and substantially improve pedestrian dispersal, safety and access

### 4\_34

Footpath extensions at intersections

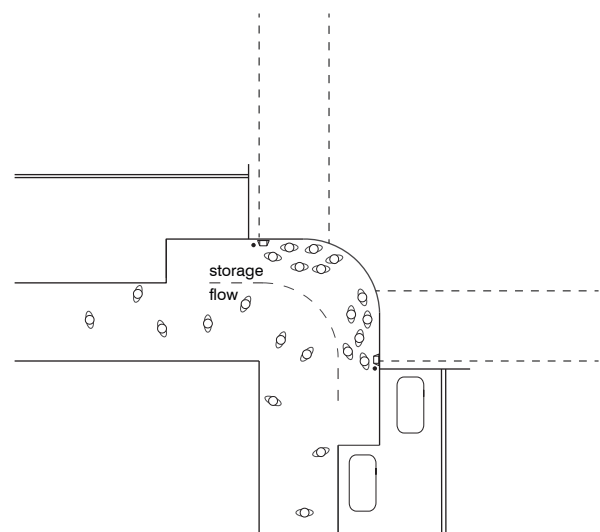

## 22 | Open space and public domain

Central Sydney is supported by an interconnected network of public places, including streets, lanes, parks, squares and plazas. Public space is critical to the public life of Central Sydney. At a basic level, a well-connected and high-quality network of public places is necessary for people to move around Central Sydney.

Central Sydney must provide a diversity of public places to suit diverse needs. In such a dense and constrained urban environment, streets and lanes are an important component of the public space network. They connect public spaces and, where vehicular access is managed, prioritise the needs of pedestrians.

### Objectives

- To ensure that growth in Central Sydney is supported by a high-quality network of public places
- To connect people to a diversity of public open spaces
- To ensure the public domain promotes the public life of the City

### Actions

- 22.1 Implement existing Public Domain Plans for Harbour Village North, City North and Chinatown
- 22.2 Develop a Consolidated Public Domain Strategy for Central Sydney that:
- Incorporates Precinct Public Domain Plans, and identified projects
  - Includes Public Domain Plans for the Western Edge, Midtown and Southern precincts, addressing their specific issues and challenges
  - Establishes a balanced provision of high-quality open space throughout Central Sydney, particularly addressing issues of provision, quality, connection and accessibility in the Western Edge, Midtown and Southern Precincts
  - Ensures that the use of existing public open space in Central Sydney is maximised
  - Further develops the George Street Pedestrian Spine and Three Squares concept, considering Martin Place and Wynyard as a possible additional significant cross-axis
  - Incorporates future transport routes and interchanges
  - Supports the growth of worker, resident and visitor numbers
- 22.3 Ensure development of new metro stations is tied to significant improvement of surrounding public places
- 22.4 Connect gaps in the network of open space that surrounds Central Sydney by delivering high-quality, green and pedestrian priority links at the south between Darling Harbour, Railway Square and Belmore Park via Quay Street and Hay Street; and improved connection between the Ultimo Pedestrian Network and Railway Square

22.5 Investigate and identify opportunities to improve connectivity to the existing ring of open space surrounding Central Sydney, particularly in the Western Edge, Southern and Midtown Precincts by:

- Strengthening existing connections to open space, addressing issues of legibility, quality and ease of access
- Providing through-site links within significant new development in the Western Edge Precinct, particularly on street blocks between Clarence and Sussex Streets, where the grade is most difficult, and between Erskine and Bathurst Streets, where at grade connections are not currently possible

22.6 Address the undersupply of public space in Central Sydney by:

- Progressing development of a future Town Hall Square
- Extending the pedestrianisation of George Street to Railway Square

22.7 Identifying opportunities to provide new and additional public open space through significant new development, particularly in the Western Edge, Southern and Midtown Precincts

22.8 Improve the quality and accessibility of existing significant open spaces to provide a higher intensity of use:

- In all open spaces: consider additional seating to support increased visitation
- In Hyde Park: investigate a pedestrian connection over Park Street to unite the two halves of the park and provide better pedestrian connectivity through Hyde Park between the north and south precincts
- In Belmore Park: investigate opportunities for better connections to surrounding development, and consider improvements to support increasing intensity of use
- On Observatory Hill: improve access and consider the impacts of likely higher usage by the area's increased worker and resident populations

22.9 Manage the impact of digital and illuminated signage on the public domain

Open space actions

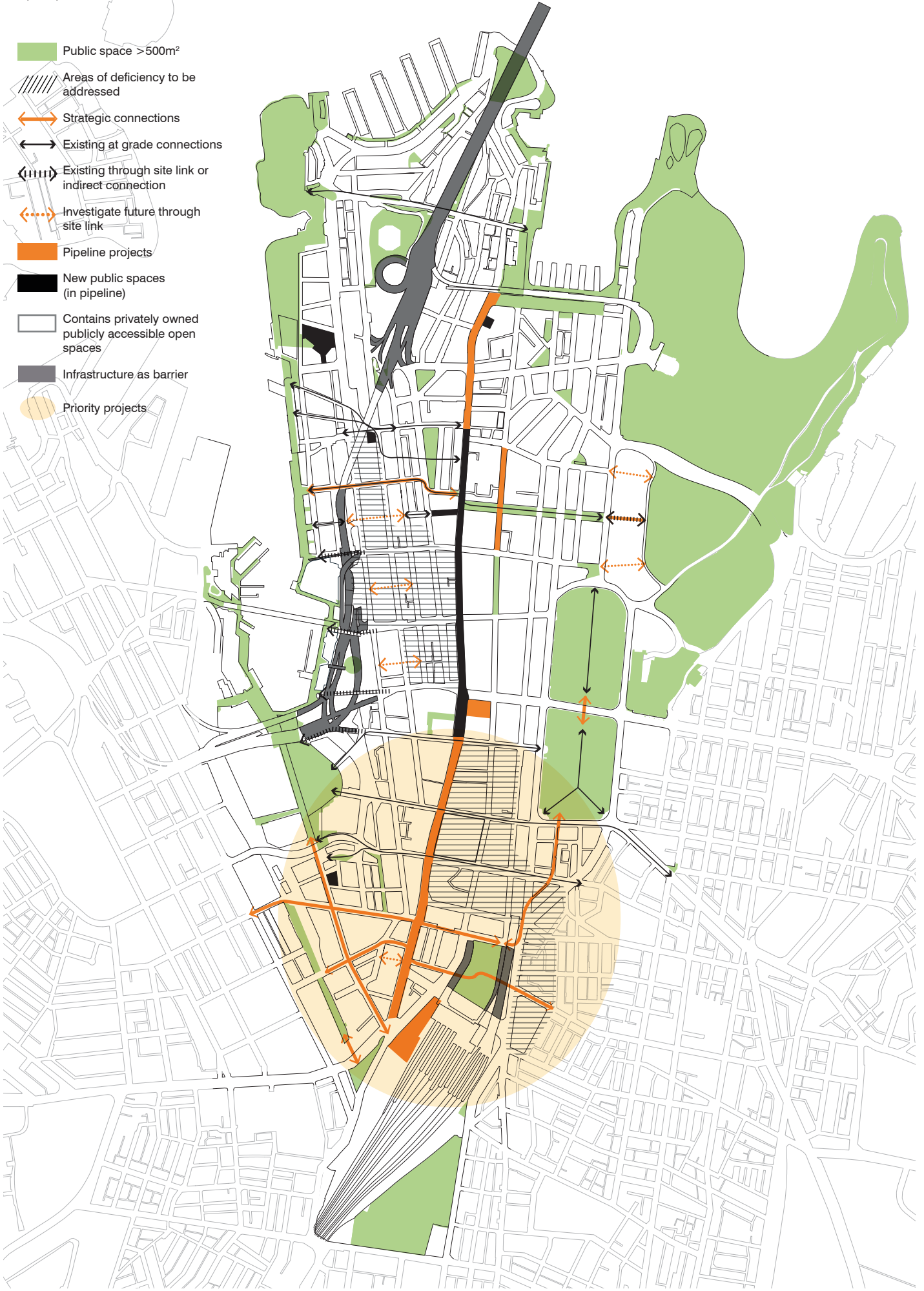

## 23 | Ground-level frontages

Active ground-level frontages are attractive, create life at street level and provide important services that help local employers attract the best employees. Central Sydney's specialised retail, food and beverage, entertainment and general services are a key factor in ensuring its attractiveness as a premier place to work. Maintaining and increasing the provision of these facilities is a key component of the Strategy to maintain the attractiveness of Central Sydney as the most prestigious employment location in Australia.

The public domain and pedestrian environment should be characterised by excellence in design, high-quality materials and well-integrated public art. A diverse range of activities should be provided at street level to reinforce the vitality and liveliness of the public domain that attract different people at different times of the day and provide services at all hours.

Active frontages to streets are encouraged so activities within buildings can positively contribute to the public domain. Such uses include retail, customer service areas, cafes and restaurants, building entries, active private open spaces and other uses that involve pedestrian interest and interaction. Outdoor dining areas may also contribute to active street frontages in appropriate circumstances.

### Objectives

- To provide a diversity of tenancies that support the social, cultural, economic and lifestyle services that provide for the day-to-day needs of Central Sydney's workforce, visitors and the wider community
- To maximise the number of retail, entertainment, and food and beverage tenancies at ground level fronting streets and lanes
- To promote continuous fine-grain frontages to all streets in Central Sydney
- To ensure that tenancies contribute to activity, safety and the amenity of public places
- To minimise the impact of inactive frontages created by building services, vehicular entries, collonades, building setbacks, and the like
- To ensure overly large building foyers do not diminish opportunities for retail tenancies
- To provide very high-quality architecture in terms of scale, finishes and architectural character and materials at ground level
- To contribute to footpath space in areas of pedestrian crowding, particularly at intersections
- To provide weather protection to adjacent footpaths with awnings
- To provide through-block arcades and links in long blocks
- To accommodate access to underground stations and other services, such as toilets, storerooms and kiosks, that support activity in the public domain
- To minimise and ameliorate the effect of blank walls (with no windows or entrances) at ground level

### Actions

- 23.1 Incorporate detailed planning provisions in the Sydney Development Control Plan that will ensure high-quality ground-level design outcomes in Central Sydney:
- 23.2 Ground-level tenancies are to contribute to the liveliness and vitality of streets by:
  - Maximising entries to shops and/or food and drink premises or other uses, customer service areas and activities which provide pedestrian interest and interaction
  - Minimising blank walls with no windows or doors.
  - Minimising building services including substations, fire services, fire escapes, service doors, plant and equipment hatches
  - Providing elements of visual interest, such as display cases, or creative use of materials where fire escapes, service doors and equipment hatches cannot be avoided
  - Providing, for a minimum of 70 per cent of the ground-floor frontage of each tenancy, display windows as transparent glazing with unobstructed view from the adjacent footpath to a depth of at least 6 metres within the building
  - Requiring the ground-floor level to be at the same level as the footpath
  - Screening car parking areas with active uses to a minimum depth of 6 metres from any facade visible to the street or public domain
  - Providing three floors of retail (basement, ground and first floor) in the blocks bounded by George, Market, King and Castlereagh Streets
- 23.3 Require development to maximise the provision of the number of tenancies and total floor space of retail, service and food and beverage tenancies at every frontage to a public place with zero setback
- 23.4 Active frontages include retail, food and beverage, entertainment and walk-in service tenancies
- 23.5 Limit the maximum size of foyers as a proportion of each development frontage are limited. Large foyers are encouraged to be located away from corners and above street level
- 23.6 Require through-site links on any site with frontages to more than one public place, each greater than 35 metres wide. The link must be:
  - Between 3 metres and 6 metres in width
  - Fronted at ground level by active uses and not include any steps
  - Open at each end, connecting street to street with a clear line of sight between entrances
  - Publicly accessible from 6am to 10pm each day
  - Provided with escalators where there are level changes between streets



- 23.7** Vehicular access to is to be:
- Restricted in places of current and future projected high pedestrian activity identified on the Pedestrian Priority map
  - Restricted on sites smaller than 1,000 square metres
  - Flush with the pavement on the footpath
  - The width of a single vehicle crossing with a maximum width of 3.6 metres over the footpath, and perpendicular to the kerb alignment
  - Shared or amalgamated between adjoining developments
  - Combine with service vehicle and parking access
- 23.8** Encourage building services, vehicular access and loading to be provided on new lanes or covered lane like shared zone areas and require building services to be provided above or below ground level where possible (e.g. substations)
- 23.9** Require setbacks at ground level at intersections to create more than 5 metres of footpath space measured from the kerb to a distance of at least 10 metres using chamfers, where adjacent footpaths are crowded or projected to become crowded
- 23.10** Require ground-level architecture to be designed with significant detail, at a fine scale with skilled craft and workmanship of high-quality material
- 23.11** Develop a required through-site links map, focusing on areas near stations to allow efficient dispersal of pedestrians

**4\_36**  
Services located away from public domain frontage

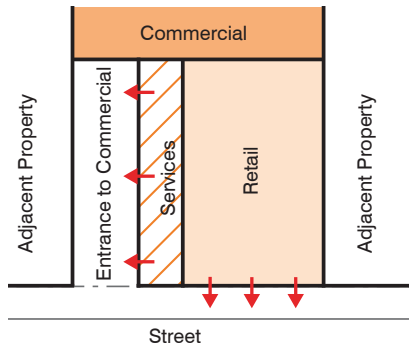

**4\_37**  
Active frontage requirements

|   | Frontage  |   |
|---|---|---|
|   | Retail core/key pedestrian routes                 | Other frontages                                   |
| Minimum active public place frontage (per street frontage)  | 5m or 80% of each frontage (whichever is greater) | 5m or 70% of each frontage (whichever is greater) |
| Minimum preferred "grain" of retail, food & beverage and service tenancies                          | 15-20 separate tenancy entries per 100m           | 10-20 separate tenancy entries per 100m           |
| Preferred maximum average ground floor tenancy width  | 6m  | 10m   |
| Minimum proportion of retail floor space provided as small tenancies (less than 100m <sup>2</sup> ) | 20%   | 30%   |
| Awnings   | Fixed   | Fixed or retractable                              |

**4\_38**  
Active frontage requirements

|   | Frontage  |   |
|---|---|---|
|   | Retail core/key pedestrian routes                   | Other frontages                                       |
| Maximum foyer width as a proportion of each street frontage (including internal cafes etc.) | 10m or 30% (whichever is lesser to a minimum of 4m) | 12.5m or 40% (whichever is lesser to a minimum of 5m) |
| Maximum foyer height  | Equal to width                                      | Equal to width  |

## 24 | Awnings and colonnades

Awnings are important for the amenity and attractiveness of streets and provide critical protection from the weather for pedestrians. Appropriately designed awnings create attractive pedestrian environments, allow daylight to the footpath and ensure clear visibility on the street. Colonnades are generally not appropriate because they block the views of retail spaces and separate the street from shopfronts.

### Objectives

- To encourage footpath awnings that will enhance pedestrian amenity and provide weather protection
- To discourage colonnades

### Actions

- 24.1 Review incentives for infilling of existing colonnades
- 24.2 Require provision of awnings that provide sun and rain protection to footpaths
- 24.3 Develop a City of Sydney standard smart-glazed awning that lets daylight through to the footpath for the majority of the year and that can turn opaque to block sun in periods of intense direct sun in summer
- 24.4 Develop standards for colonnades
- 24.5 Ensure awnings are provided to all developments that are:
  - Continuous across all frontages of the property to public places
  - Between 3.2 metres and 4.2 metres above the footpath
  - Generally at least 3.6 metres deepAnd that they:
  - Maximise weather protection and daylight to the footpath
  - Retain any heritage-significant fabric
  - Utilise the City of Sydney standard glazed awning detail

## 25 | Public art

Public art is a defining quality of dynamic, interesting and successful cities. Well-integrated ecologically sustainable public art is encouraged in new development. Developers, architects, landscape architects and artists should be involved in producing public artworks.

### Objectives

- To increase the number of public artworks
- To ensure that public art is integrated with new development

### Actions

- 25.1 Support the continued application of the City of Sydney's existing Public Art Policy by developing a rate for contribution to public art linked to capital investment value, generally in the order of 1 per cent for moderate-sized projects sliding to 0.5 per cent for very large projects

## 26 | Energy and water efficiency

The Strategy is in alignment with and seeks to support the City's other sustainability strategies including the Climate Adaption Strategy, the Residential Apartments Sustainability Plan and the Energy Efficiency Master Plan.

### Objectives

- To improve the energy efficiency of buildings by reducing energy intensity per square metre
- To move towards a net-zero carbon precinct
- To reduce potable water consumption through water efficiency and connection to recycled water
- To assist in reducing future infrastructure costs

### Priority action

- 26.1 Require all new tower development to meet BASIX+ targets and minimum 5 star NABERS ratings

### Actions

- 26.2 Use the City of Sydney's strategic partnerships to advocate for higher energy targets in BASIX and the energy efficiency provisions in the National Construction Code
- 26.3 Achieve best-practice energy intensity targets in new buildings and major refurbishments
- 26.4 Ensure major new development areas commit to be zero-net energy or climate-positive
- 26.5 Ensure buildings are designed to achieve the highest possible thermal comfort levels and performance criteria through passive means to avoid artificial energy demand and consumption
- 26.6 Ensure mechanical heating and cooling services are avoided or where applied use best-in-class energy-efficient technologies
- 26.7 Ensure individual buildings and large-scale developments are designed to maximise the generation and use of local renewable energy
- 26.8 Investigate City of Sydney provision of zero or low-carbon precinct-scale services where demonstrated to be most efficient and feasible
- 26.9 Specify optimal lighting levels in buildings and the public domain and use the most energy-efficient technologies
- 26.10 Ensure all new major developments include the capacity to generate 10 per cent of their total energy onsite using renewable energy sources
- 26.11 Require best-practice water efficiency design, for example efficient fixtures and fittings, and dual-plumbing to enable connection to recycled water
- 26.12 Ensure precincts are designed for the collection, treatment and reuse of locally generated wastewater, stormwater and rainwater for non-potable use including toilet flushing, laundry, cooling and irrigation
- 26.13 Maintain green space using locally sourced, independent water supplies

## 27 | Wind

The wind environment is a major determinant of amenity in public places. Tall buildings can create or exacerbate windy conditions in built-up areas. Very tall buildings can have a significant effect on the wind environment at street level.

Buildings must be designed to mitigate unsafe and uncomfortable wind effects on public places and should create comfortable and pleasant conditions through design skill.

Generally, the provision of a reasonably sized podium will mitigate the greatest wind effects from tall buildings. Provision of podia is particularly important at the exposed edges of the city where wind speeds are highest and buildings are not shielded by neighbouring buildings.

Movement of air disperses pollutants. Creating space between towers and minimising the height and length of urban canyons created by tall buildings is important to ensuring reasonable air quality at street level.

### Objectives

- To ensure streets and public places have wind conditions that are safe and comfortable for walking and sitting
- To ensure new developments mitigate wind effects
- To ensure that wind speeds in public places do not create unsafe conditions
- To ensure air quality does not exceed environmental and health standards
- To provide wind climate data that can be applied consistently to new developments

### Actions

- 27.1 Incorporate detailed wind provisions and standards for safety and comfort into Central Sydney planning controls based on wind speed and frequency:
- Define the mandatory Wind Safety Standard as an annual maximum peak 0.5 second gust wind speed in one hour measured between 6am and 10pm Eastern Standard Time (EST) of 24 metres per second
  - Define the mandatory Wind Comfort Standard for Walking as an hourly mean wind speed, or gust equivalent mean wind speed, whichever is greater for each wind direction, for no more than 292 hours per annum measured between 6am and 10pm EST (i.e. 5 per cent of those hours) of 8 metres per second
  - Define the mandatory Wind Comfort Standard for Sitting in Parks as an hourly mean wind speed, or gust equivalent mean wind speed, whichever is greater for each wind direction, for no more than 292 hours per annum measured between 6am and 10pm Eastern Standard Time of 4 metres per second and applies to parks protected by Sun Access Planes and/or No Additional Overshadowing Controls

- Define the desirable Wind Comfort Standards for Sitting and Standing as an hourly mean wind speed, or gust equivalent mean wind speed, whichever is greater for each wind direction, for no more than 292 hours per annum measured between 6am and 10pm EST of:

- 4 metres per second for sitting
- 6 metres per second for standing

27.2 Consider introducing four perimeter wind monitors around Central Sydney to establish common wind climate data

27.3 Review and update wind environment data every five years

## 28 | Apartment amenity in Central Sydney

The Strategy supports high levels of amenity in apartments, as specified in the NSW Government's SEPP 65 and Apartment Design Guide (ADG). The Strategy recognises that the maintenance of sunlight access to residential apartments should not unduly restrict the economic performance and growth of Central Sydney.

In Central Sydney's dynamic development environment, residential and commercial buildings will inevitably be located in close proximity. Residential buildings can place significant constraints on the development of new employment floor space, particularly if they are to retain sunlight access and privacy.

To ensure opportunities for Central Sydney's growth as an employment hub (and to balance this with adequate future amenity for residents), new residential building assessments should assume that nearby sites that may impact on their amenity have already been developed to their full development potential and height. This allows for a comprehensive assessment of impacts, and limits the potential degradation of sunlight and privacy to new buildings in the future.

### Objectives

- To ensure all new residential buildings meet minimum amenity provisions consistent with SEPP 65 and the Apartment Design Guide based on potential future built out context under Sydney LEP 2012
- To ensure robust assessment of sunlight access to new residential buildings
- To ensure the development of new commercial buildings is not unreasonably impeded by existing residential buildings

### Actions

- 28.1 Test compliance with the Solar Access Design Criteria of the ADG in the current context and Central Sydney's assumed probable future context that contains the maximum possible commercial development on sites that may overshadow the development in the future
- 28.2 Ensure residential development does not restrict new commercial development

## 29 | Planning governance

The role of planning is to ensure that the sum of development activity achieves government strategic policy directions. For investment in development to operate efficiently the planning system must provide high levels of certainty. For the public to have confidence in the planning system development must be of very high quality and provide public benefit and manage public costs.

For the planning system in Central Sydney to deliver quality, consistency and confidence it must be unified. The present division of responsibility between the NSW Government and the City undermines both business and community confidence that outcomes will exhibit both quality and consistency. Additionally where decision making is not holistic choices may be made that are inconsistent with overall strategic directions.

### Objectives

- To ensure the planning system creates high levels of certainty to allow economic growth through investment
- To grow confidence in the planning system through clear, consistent and predictable decision making resulting in high quality urban outcomes
- To unify planning and consent functions and pathways under the Central Sydney Planning Committee to avoid inconsistent decision making undermining confidence in the planning system
- To ensure the planning and consent authority has sufficient capability to deliver quality planning services in a timely manner
- To coordinate state and local government planning in Central Sydney
- To coordinate transport infrastructure planning with land use planning

### Actions

- 29.1 Increase public confidence in local planning decisions by working with the NSW Government to revise state-significant cost thresholds and to transfer land back to the City of Sydney
- 29.2 Ensure the Central Sydney planning framework is clear and is applied consistently
- 29.3 Ensure planning services for development in Central Sydney are well resourced to ensure quality and timely plan making and assessment functions
- 29.4 Work with Transport for NSW (and subsidiary agencies) to improve efficient transport access to and within Central Sydney
- 29.5 Work with the NSW Government to fully implement the Strategy within Sydney LEP

